

REED

Model ST-8839

Non-Contact Infrared Thermometer



Instruction Manual

www.reedinstruments.com

Table Of Contents

| | |
|-----------------------------------|-----|
| Safety | 2 |
| Features..... | 3 |
| Specifications..... | 3-4 |
| Instrument Description | 5-6 |
| Operating Instructions..... | 6-9 |
| <i>Applications</i> | 6 |
| <i>MODE Button Function</i> | 7 |
| <i>Switching Settings</i> | 7 |
| <i>Cleaning</i> | 8 |
| <i>Notes</i> | 8-9 |
| Battery Replacement..... | 10 |

Safety

- Use extreme caution when the laser beam is turned on
- Do not let the beam enter your eye, another person's eye or the eye of an animal
- Be careful not to point the beam off a reflective surface & into your eye
- Do not allow the laser light beam to impinge on any gas which can explode



Features

- Precise non-contact temperature measurement
- Unique flat surface, modern housing design
- Built-in laser pointer
- Automatic Data Hold
- Automatic power off
- °C/°F switch
- Emissivity, digitally adjustable from 0.10 to 1.0
- MAX, MIN, DIF, AVG record
- LCD with backlight
- Automatic range selection
- Resolution 0.1°C (0.1°F)
- Trigger lock
- High and Low alarms

Specifications

IR Measurement:

| | | |
|----------------------|--------------------------------|--------------------------------|
| IR Temperature Range | -50 to 1000°C (-58 to 1832°F) | |
| Distance : Spot size | 50:1 | |
| Resolution | 0.1° up to 200°; 1° over 200° | |
| Accuracy | -50 to -20°C (-58 to -4°F) | ±5°C (±9°F) |
| | -20 to 200°C (-4 to 392°F) | ±1.5% of reading ±2°C (±3.6°F) |
| | 200 to 538°C (392 to 1000°F) | ±2.0% of reading ±2°C (±3.6°F) |
| | 538 to 1000°C (1000 to 1832°F) | ±3.5% of reading ±5°C (±9°F) |

Response Time: Less than 1 second

Spectral Response: 8~14µm

Emissivity: Digitally adjustable from 0.10 to 1.0

Over Range Indication: LCD will show “-OL”, ”0L”

Polarity: Automatic (no indication for positive polarity);
Minus (-) sign for negative polarity

continued ...

| | |
|--------------------|---|
| Diode Laser: | Output <1mW, Wavelength 630~670nm, Class 2 (II) laser product |
| Operating Temp.: | 0 to 50°C (32 to 122°F) |
| Storage Temp.: | -20 to 60°C (-4 to 140°F) |
| Relative Humidity: | 10%~90% RH operating, <80%RH storage |
| Power Supply: | 9V battery, NEDA 1604A or IEC 6LR61, or equivalent |
| Dimensions: | 100 x 56 x 230mm (3.9 x 2.2 x 9.0") |
| Weight: | 290g (10.2 oz) |
| Safety: | "CE" Comply with EMC |
| Includes: | Battery, carrying case & instruction manual |

Notes

- **Accuracy:** Given at 18 to 28°C (64 to 82°F), less than 80% RH
- **Field of View:** Make sure that the target is larger than the unit's spot size. The smaller the target, the closer you should be to it. When accuracy is critical, make sure the target is at least twice as large as the spot size

Distance & Spot Size

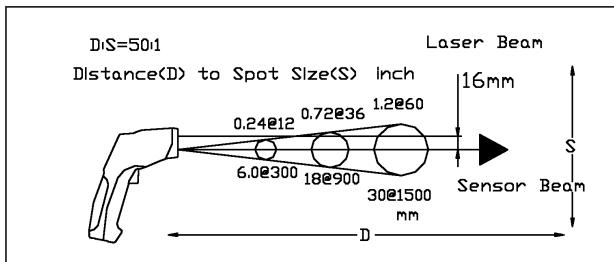

As the distance (D) from the object increases, the spot size (S) of the area measured by the unit becomes larger. The relationship between distance and spot size for each unit is listed below. The focal point for each unit is 914mm (36"). The spot sizes indicate 90% encircled energy.

Instrument Description

1. IR Sensor
2. Laser Pointer Beam
3. LCD Display
4. Down Button
5. Up Button
6. Mode Button
7. Laser/Backlight Button
8. Measurement Trigger
9. Handle Grip
10. Battery Cover

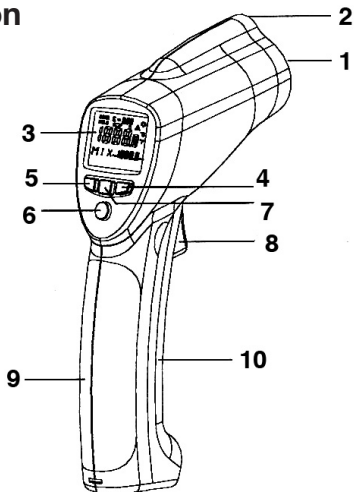

Display Description

1. Data Hold
2. Measuring indication
3. Emissivity symbol & value
4. Low battery, lock & laser "on"
5. Backlight "on" symbol
6. °C/°F symbol
7. High & low alarm symbols
8. Temperature values for the MAX, MIN, DIF, AVG HAL & LAL
9. Symbols for EMS MAX, MIN, DIF, AVG, HAL & LAL
10. Current temperature value

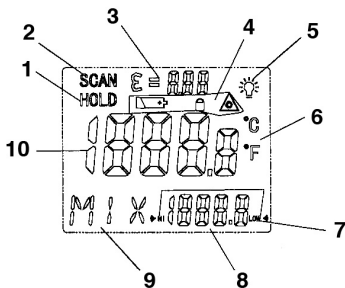

continued ...

Button Description

1. Up button
(for EMS, HAL, LAL)
2. MODE button
(for cycling through the mode loop)
3. Down button
(for EMS, HAL, LAL)
4. Laser/Backlight On/Off button
(pull trigger & press button to activate laser/backlight)

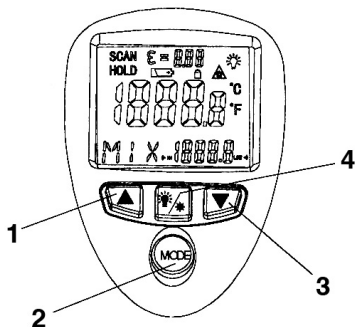

See page 7 for more details.

Operating Instructions

1. Hold the meter by its handle grip and point it toward the surface to be measured
2. Pull and hold the trigger to turn the meter on and begin testing. The display will light if the battery is good. Replace the battery if the display does not light
3. While measuring, the SCAN display icon will appear in the upper left corner of the LCD
4. Release the trigger and the HOLD icon will appear on the LCD indicating that the reading is being held
5. The meter will automatically power off approximately 7 seconds after the trigger is released. Unless the unit is locked on

Applications

Food preparation, safety and fire inspectors, plastic molding, asphalt, marine and screen printing, measure ink and dryer temperature, HVAC/R, diesel, fleet maintenance and much more.

continued ...

MODE Button Function

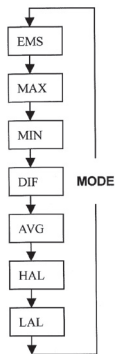

This infrared thermometer measures Maximum (MAX), Minimum (MIN), Differential (DIF), and Average (AVG) Temperatures. Each time you take a reading, this data is stored and can be recalled with the MODE button until a new measurement is taken. When the trigger is pulled again, the unit will begin measuring in the last mode selected.

Pressing the MODE button also allows you to access the High Alarm (HAL), Low Alarm (LAL) & Emissivity (EMS). Each time you press MODE, you advance through the mode cycle. The diagram on the left shows the sequence of functions in the MODE cycle

Switching Settings

1. C/F
2. LOCK ON/OFF
3. SET ALARM

Select the temperature units ($^{\circ}\text{C}$ or $^{\circ}\text{F}$) by using the $^{\circ}\text{C}/^{\circ}\text{F}$ switch. To lock the unit on for continuous measurement, slide the middle switch **LOCK ON/OFF** to the right. If the trigger is pulled while the unit is locked on, the laser and backlight will be turned on if they have been activated. When the unit is locked on, the backlight and laser will remain on unless it is turned off using the **Laser/Backlight** button on the keypad. To activate the alarms, please slide the bottom switch **SET ALARM** to the right. To set values for the High Alarm (**HAL**), Low Alarm (**LAL**) and Emissivity (**EMS**), firstly activate the display by pulling the trigger or pressing the **MODE** button, then press the **MODE** button until the appropriate code appears in the lower left corner of the display, press the **UP** and **DOWN** buttons to adjust the desired values.

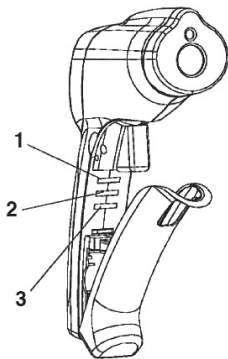

Cleaning

- Periodically wipe the case with a dry cloth. Don't use abrasives or solvents on this instrument

Notes

How it Works

This REED Infrared Thermometer measures the surface temperature of an object. The unit's optics sense emitted, reflected, and transmitted energy which is collected and focused onto a detector. The unit's electronics translate the information into a temperature reading which is displayed on the unit. In units with a laser, the laser is used for aiming purposes only.

Field of View

Make sure that the target is larger than the unit's spot size. The smaller the target, the closer you should be to it. When accuracy is critical, make sure the target is at least twice as large as the spot size.

Distance & Spot Size

As the distance (D) from the object increases, the spot size (S) of the area measured by the unit becomes larger. See Graphic on Page 4.

Locating a Hot Spot

To find a hot spot aim the thermometer outside the area of interest, then scan across with an up and down motion until you locate hot spot.

Reminders

1. Not recommended for use in measuring shiny or polished metal surfaces (stainless steel, aluminum, etc.). See Emissivity (page 9)
2. The unit cannot measure through transparent surfaces such as glass. It will measure the surface temperature of the glass instead
3. Steam, dust, smoke, etc., can prevent accurate measurement by obstructing the unit's optics

continued ...

Emissivity

Emissivity is a term used to describe the energy-emitting characteristics of materials. Most (90% of typical applications) organic materials and painted or oxidized surfaces have an emissivity of 0.95 (pre-set in the unit).

Inaccurate readings will result from measuring shiny or polished metal surfaces. To compensate, cover the surface to be measured with masking tape or flat black paint. Allow time for the tape to reach the same temperature as the material underneath it. Measure the temperature of the tape or painted surface.

Emissivity Values

| Substance | Thermal Emissivity | Substance | Thermal Emissivity |
|------------------|---------------------------|-------------------|---------------------------|
| Asphalt | 0.90 to 0.98 | Cloth (black) | 0.98 |
| Concrete | 0.94 | Human skin | 0.98 |
| Cement | 0.96 | Lather | 0.75 to 0.80 |
| Sand | 0.90 | Charcoal (powder) | 0.96 |
| Earth | 0.92 to 0.96 | Lacquer | 0.80 to 0.95 |
| Water | 0.92 to 0.96 | Lacquer (matt) | 0.97 |
| Ice | 0.96 to 0.98 | Rubber (black) | 0.94 |
| Snow | 0.83 | Plastic | 0.85 to 0.95 |
| Glass | 0.90 to 0.95 | Timber | 0.90 |
| Ceramic | 0.90 to 0.94 | Paper | 0.70 to 0.94 |
| Marble | 0.94 | Chromium oxides | 0.81 |
| Plaster | 0.80 to 0.90 | Copper oxides | 0.78 |
| Mortar | 0.89 to 0.91 | Iron oxides | 0.78 to 0.82 |
| Brick | 0.93 to 0.96 | Textiles | 0.90 |

Battery Replacement

1. When battery power is not sufficient, LCD will display “” and replacement with one new 9V battery is required
2. Open battery cover, take out the battery from the instrument and replace with a new 9V battery and place the battery cover back into place

For service on this or any other REED product or information on other REED products, contact REED Instruments at info@reedinstruments.com

Notes

Notes _____

Notes _____
