

Pneumatic High-Speed Pressure Controller Model CPC3000

Data Sheet CPC3000 • 02/2014



Applications

- Industry (laboratory, workshop and production)
- Pressure transmitter manufacture
- Calibration service companies
- Research and development laboratories

Special features

- Pressure ranges:
 - Gauge: 0 ... 5 up to 0 ... 1500 psig
 - Absolute: 0 ... 15 to 0 ... 1515 psia
 - Bi-directional: $5 \leq \text{span} \leq 1515$
- Control speed: < 3 seconds.
- Uncertainty: 0.025% FS (365 day calibration interval)
Optional Uncertainty 0.025% IS-50 (365 day calibration interval)
- Bezel and Handle
- Includes A2LA/NIST Calibration Certificate



High-Speed Pneumatic Pressure Controller Model CPC3000

Description

Overview

The CPC3000 has a compact, light weight design, a reliable high speed pressure regulator, gauge / absolute / bi-directional ranges and an optional barometric reference for emulation. These qualities make the CPC3000 suitable for a variety of applications.

Applications

With an uncertainty of 0.025% FS and a high speed regulator, the CPC3000 is well suited for use in the production of pressure sensors, transmitters, transducers, and pressure switches or as a working standard for the control and calibration of all types of pressure gauges.

Functionality

A color touch-screen, combined with user-friendly menus, guarantees high productivity in a calibration lab or production facility; all screens can be viewed in several different languages.

To enter the pressure setpoint, the operator can choose between four input modes which can be selected using the corresponding tab. The input modes are:

1. The numeric key menu provides a way to enter a specific pressure set point value to be controlled.

2. The step keypad menu provides defined steps programmed in pressure increments or percent of a user defined span to move the pressure setpoint across the range of the instrument under test.
3. The jog key menu provides a way for the operator to define small pressure steps up or down to reach a cardinal point on a dial gauge. The jog buttons increment the least significant digit by 1, 10 or 100 counts.
4. The user defined Jog menu provides a way for the operator to define any step within the span to increase or decrease the setpoint.

Software

Customers can create their own test programs using the Mensor communication command set, the SCPI command set or the emulation command set used when replacing other calibrators.

Complete testing and calibration systems

Communication with other instruments is made easy with an IEEE-488.2, an Ethernet and a USB interface. The CPC3000 can be integrated into an existing system, or our Custom Systems group can design a system to meet a specific need.

Data Sheet CPC3000 • 02/2014

Page 1 of 8

Dimensions in inches

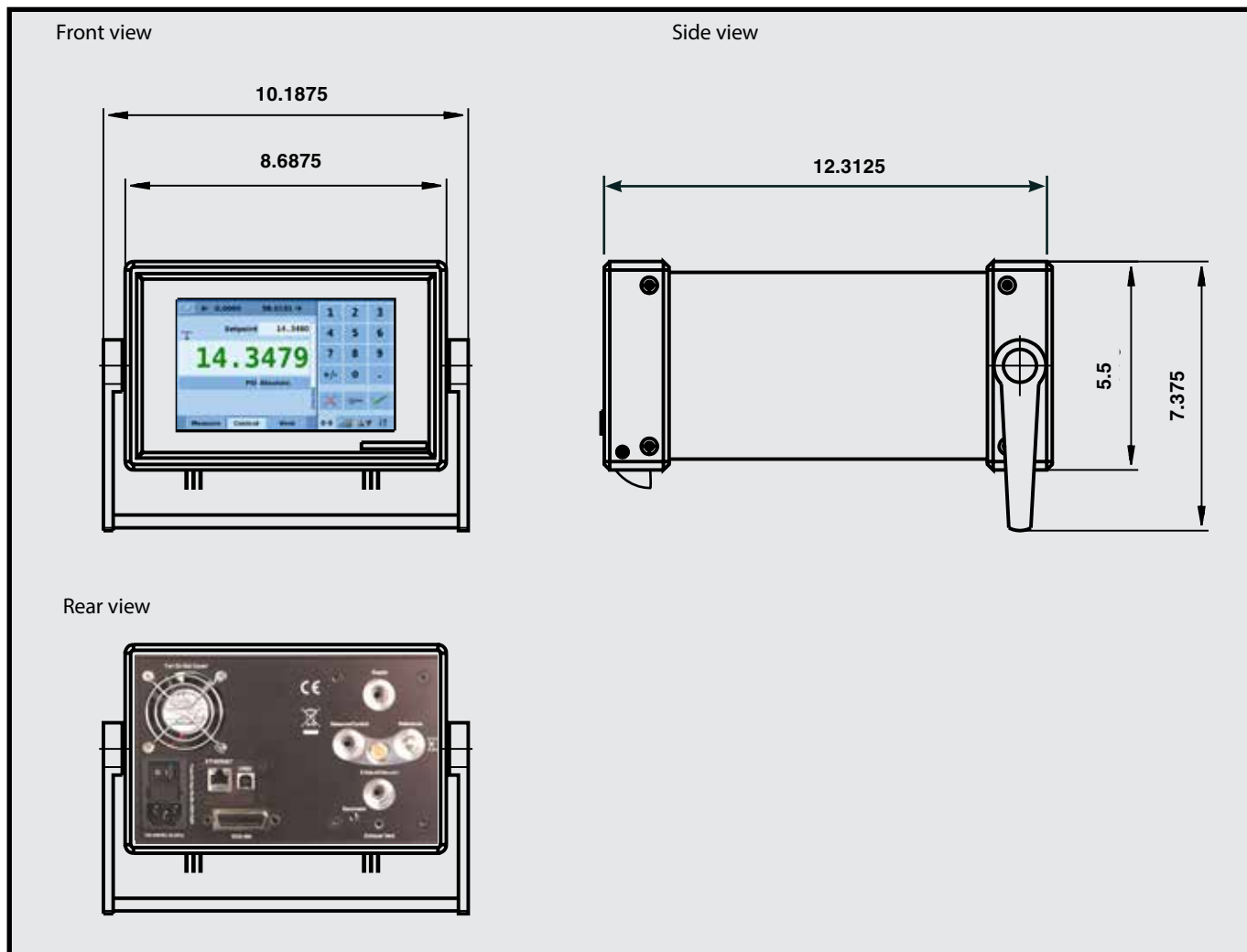

Electrical connections and pressure ports - rear view



Specifications	CPC 3000																				
Pressure ranges	Gauge: 0 ... 5 up to 0 ... 1500 psig (0 ... 0.35 to 0 ... 103 bar) Absolute: 0 ... 14.5 to 0 ... 1515 psia (0 ... 1 to 0 ... 104 bar) Bi-directional: 5 ≤ span ≤ 1515																				
Pressure types	Absolute, gauge or bi-directional ranges																				
Uncertainty	0.025% full span for all standard pressure ranges specified above. Uncertainty (k=2) includes hysteresis, linearity, repeatability, reference standard, drift and temperature effects over the calibrated range for the calibration interval specified, with periodic re-zeroing.																				
Optional Intelliscale Uncertainty	<table border="1"> <thead> <tr> <th colspan="2">Gauge</th> </tr> </thead> <tbody> <tr> <td>Transducer Range (psig)</td> <td>Total Uncertainty ⁽¹⁾ (cal interval)</td> </tr> <tr> <td>0 ... 14.5 to 0 ... 1500</td> <td>0.025% IS-50 ⁽¹⁾ (365 days)</td> </tr> <tr> <th colspan="2">Absolute</th> </tr> <tr> <td>Transducer Range (psia)</td> <td>Total Uncertainty ⁽¹⁾ (cal interval)</td> </tr> <tr> <td>0 ... 14.5 to 0 ... 1515</td> <td>0.025% IS-50 ⁽¹⁾ (365 days)</td> </tr> <tr> <th colspan="2">Bi-directional</th> </tr> <tr> <td>Transducer Range (psi)</td> <td>Total Uncertainty ⁽¹⁾ (cal interval)</td> </tr> <tr> <td>-15 ... 145 to -15 ... 1500</td> <td>0.025% IS-50 ⁽¹⁾ (365 days)</td> </tr> <tr> <td>5 ≤ span < 145</td> <td>0.025% of Full Span (365 days)</td> </tr> </tbody> </table> <p>(1) 0.025% IntelliScale-50 (0.025% IS-50): Uncertainty from Min to 50% of Max = (0.025% x 50% x Max) or 0.025% of Reading from 50% to 100% of Max.</p>	Gauge		Transducer Range (psig)	Total Uncertainty ⁽¹⁾ (cal interval)	0 ... 14.5 to 0 ... 1500	0.025% IS-50 ⁽¹⁾ (365 days)	Absolute		Transducer Range (psia)	Total Uncertainty ⁽¹⁾ (cal interval)	0 ... 14.5 to 0 ... 1515	0.025% IS-50 ⁽¹⁾ (365 days)	Bi-directional		Transducer Range (psi)	Total Uncertainty ⁽¹⁾ (cal interval)	-15 ... 145 to -15 ... 1500	0.025% IS-50 ⁽¹⁾ (365 days)	5 ≤ span < 145	0.025% of Full Span (365 days)
Gauge																					
Transducer Range (psig)	Total Uncertainty ⁽¹⁾ (cal interval)																				
0 ... 14.5 to 0 ... 1500	0.025% IS-50 ⁽¹⁾ (365 days)																				
Absolute																					
Transducer Range (psia)	Total Uncertainty ⁽¹⁾ (cal interval)																				
0 ... 14.5 to 0 ... 1515	0.025% IS-50 ⁽¹⁾ (365 days)																				
Bi-directional																					
Transducer Range (psi)	Total Uncertainty ⁽¹⁾ (cal interval)																				
-15 ... 145 to -15 ... 1500	0.025% IS-50 ⁽¹⁾ (365 days)																				
5 ≤ span < 145	0.025% of Full Span (365 days)																				
Optional barometer uncertainty	0.02% R from 8.5 to 17 psia for 365 days																				
Compensated temperature range	15 to 45 °C																				
Calibration interval	365 days																				
Pressure units: English	psi, psf, oz/si, tons/sq in, tons/sq ft, atm, inHg @0C, inHg @60F, mTorr, Torr, inSW, ftSW, inH2O @4C, inH2O @20C, inH2O @60F, ftH2O @4C, ftH2O @20C, ftH2O @60F																				
Pressure units: Metric	mbar, bar, g/sq cm, kg/sq cm, dyn/sq cm, pascal, hPa, kPa, MPa, mmHg @0C, cmHg @0C, mHg 0C, mSW, mmH2O @4C, cmH2O @4C, mH2O @4C, mmH2O @20C, cmH2O @20C, mH2O @20C																				
Pressure units user defined	2 (multiplier from psi or Pascal)																				
Slew rate	3 seconds to stable flag (+/-0.025% full scale pressure) for a 10% pressure change typical into 150cc volume at pressures greater than 5 PSI. Larger volumes can lengthen this time. Controlling to pressures less than atmosphere can lengthen this time.																				
Overshoot	<1 % FS, in high speed mode																				
Control stability	0.003% of range																				
Pressure ports	7/16-20 Female SAE threaded ports for Measure/Control, Exhaust, Reference, and Supply. Barometric Reference port is a hose barb.																				
Filter elements	40 micron filter element included in each pressure port (excluding the optional barometer and the reference port on a gauge sensor)																				
Permissible pressure media	Clean, dry, non-corrosive gases																				
Parts exposed to pressure media	6000 series aluminum, 316 SS, brass, Teflon, Urethane, Silicone, RTV, Silicone grease, PVC, Epoxy, Ceramics																				
Overpressure protection	Pressure relief valves																				
Instrument mounting	Desk top with bezel and handle, or optional rack mount kit.																				
Display	7.0" color LCD																				
Resolution	Six significant digits																				
Warm-up time	approx. 15 min																				
Digital interface	IEEE-488, Ethernet, USB																				
Power supply	100 - 240 VAC, 50/60 Hz, 700 mA max																				
Maximum pressure, supply port	110 ... 120 %FS																				
Pneumatic overpressure protection	internal relief valves																				
Operating temperature	0 ... 50 °C																				
Storage temperature	0 ... 70 °C																				
Air humidity	0 ... 95 (% relative humidity without moisture condensation)																				
Operating position	Negligible, can be removed with re-zeroing																				
Weight	<20 lbs. (<9.1 kg) with all internal options																				
Dimensions	5¼ h x 8¾ w x 12 d in (133 x 213 x 305 mm)																				
CE-mark	Conformity certificate																				
Calibration	NIST traceable calibration certificate included, A2LA certification																				

Touch screen operation

Main screen

The CPC3000 main operation screen appears after powering up the unit. This screen contains all of the controls needed to navigate within the menus and to operate the instrument. The setup icon button opens up a menu that provides navigation to all the set up screens, limits indication, tab selectable input menu, set point display and selection, pressure value indication, pressure units indication and selection and measure / control / vent mode selection.

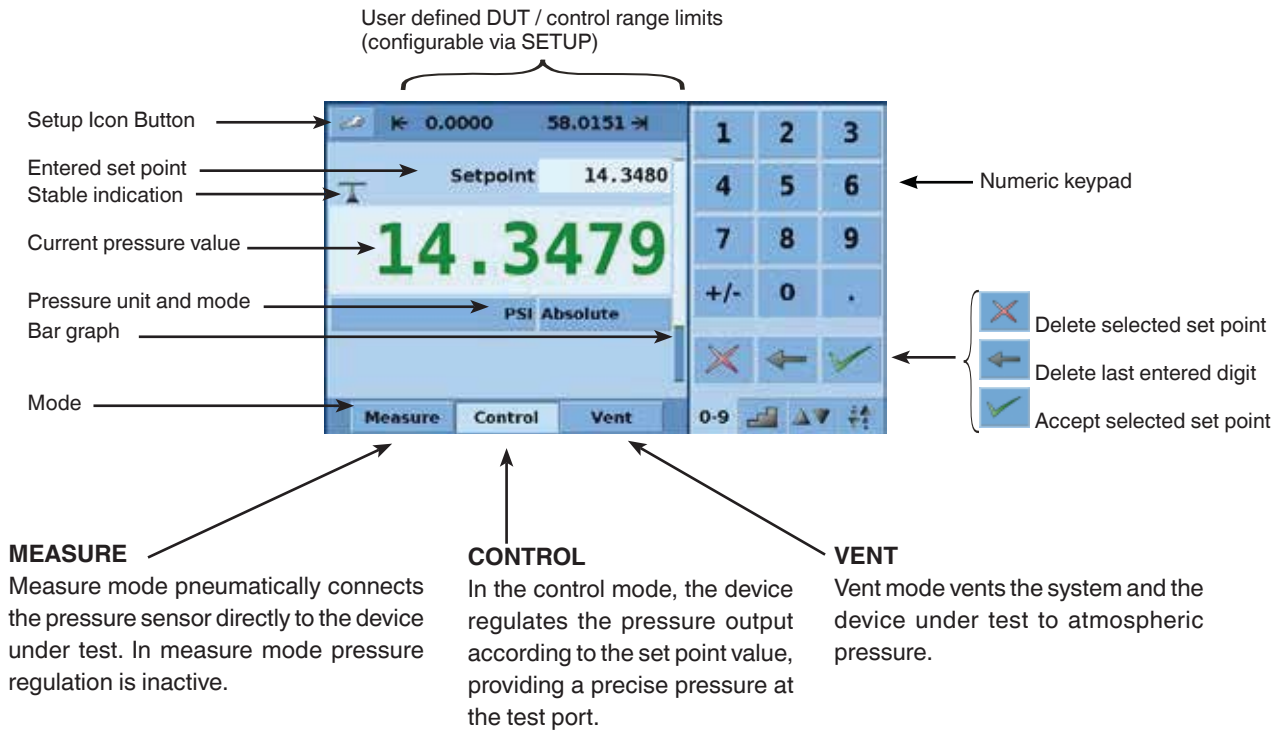

Optional information can be displayed in the main menu by selecting the option in the setup menu

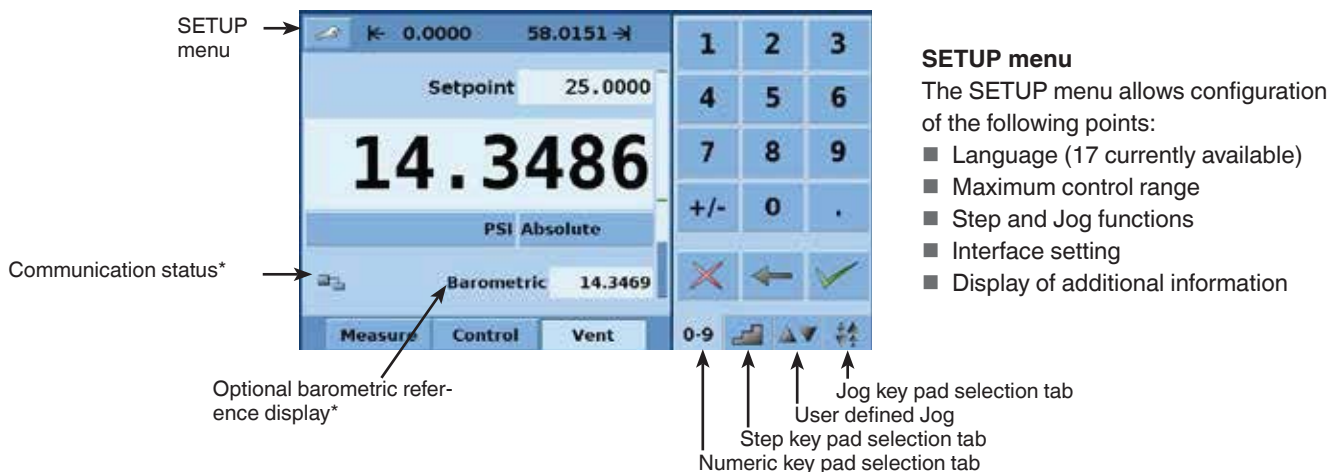

* optional display element

Note: See the following page for detailed information on each set point entry screen.

The pressure set point can be changed using one of three input modes

The numeric keypad

Application: Direct input of set point value.



← Delete input, delete last character, input acknowledgement

Numeric keypad

Operation

The desired pressure set point value is entered using the numeric keypad and then acknowledged by pressing the check mark key. In control mode the controller will regulate the output pressure to the entered value.

The step keypad

Application: Calibration of incremental user defined pressure points or percent of full span of the device under test.



Configurable via SETUP
 ■ % of span of limit value
 ■ User defined pressure steps

Step keypad

Operation

Each step on the step keypad can indicate user defined pressure values or percent of span values for the device under test. For example: the step keypad shown to the left is set for 10% steps going from 0% to 100%. These steps are a percent of the user defined device under test full span. In control mode, when a step is touched, the controller will regulate the output to the associated set point.

The jog keypad

Application: Fine adjustment of the pressure value to reach a cardinal value on a pressure gauge or similar device under test.

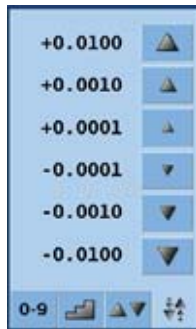

Set point increased by:
 { Least significant digit x 100
 { Least significant digit x 10
 { Least significant digit

Set point decreased by:
 { Least significant digit
 { Least significant digit x 10
 { Least significant digit x 100

Jog keypad

Operation

The triangles on the Jog keypad have values which correspond to the 3 last digits of the pressure reading and are used to increment the set point. Triangles pointing up will increase the value and those pointing down will decrease it. The smallest triangle increments the least significant digit by one, the medium size triangle increments the least significant digit by ten and The large triangle increments the least significant digit by one hundred. The values will change accordingly if the resolution of the indication is changed.

The user defined jog keypad

Application: User defined quick pressure adjustment.

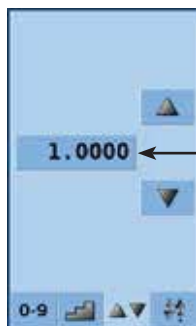

} Increase by user defined amount.
 ← User defined amount key.
 } Decrease by user defined amount.

Operation

Pressing the "User Defined Amount" key will open a numeric entry screen where a user defined amount can be entered. This value will be shown in the key indication. Pressing the triangles will increase or decrease the set point by this value.

Application — Typical Setup



Application — Setpoint entry options and function



Direct entry of setpoint using the numeric keypad: enter the setpoint value and press . The controller will then ramp up the setpoint.

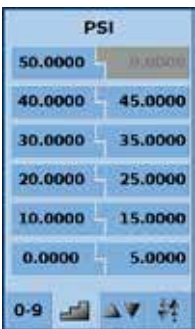
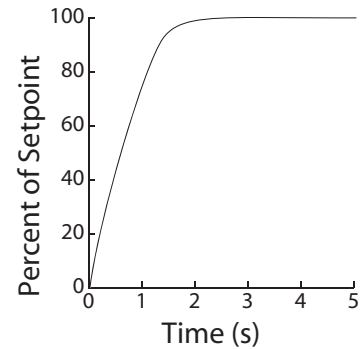

Setpoint entry using the step keypad: step changes, automatically calculated as a percent of the user defined full scale limit, and indicated in percent FS or pressure units can be entered by pressing step keys () in any sequence.

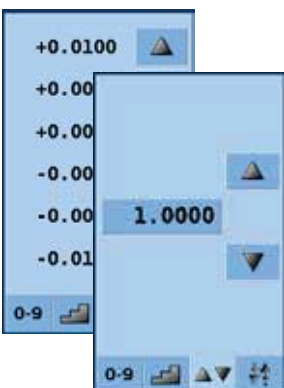
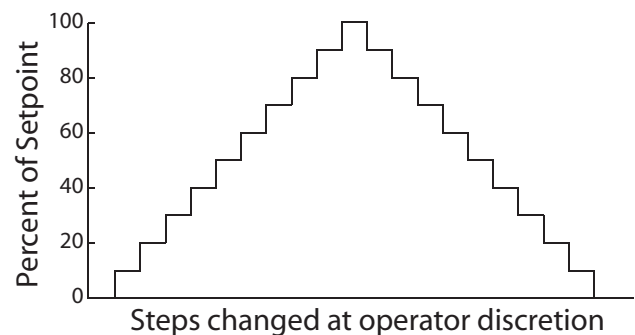

Setpoint entry using jog keypads: setpoint can be increased or decreased in small or large steps using the jog keys  to reach a cardinal point on a dial gauge or step through a calibration sequence.

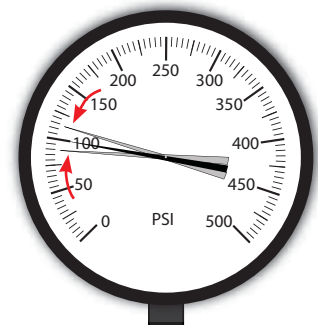

Communications

The variety of communications modes and command sets make the CPC3000 a good choice to replace older pressure controllers that communicate remotely via IEEE-488. The Mensor command set will integrate seamlessly with other Mensor controllers and the SCPI command set provides integration in areas where the SCPI command structure has been used. The CPC3000 even understands commands and automation programs that have been written previously for non-Mensor / non-WIKA controllers. Within the setup menu, under the remote tab, communication emulation selections are available to switch between the various command structures.

In addition to IEEE-488, the CPC3000 has Ethernet and USB communications making it remotely accessible to today's modern automation systems. Trouble shooting the initial remote setup is made easy by viewing the remote monitor which displays the most recent commands sent and responses from the CPC3000 plus any error messages.

Options and accessories

Barometric reference

An optional barometric reference is available for emulation of gauge pressure when the internal sensor is absolute and emulation of absolute pressure when the internal sensor is gauge. The internal gauge sensors must include a negative gauge range of one atmosphere in order to be able to emulate sub atmospheric absolute pressures.

Rack mount kit

A 19" x 3U rack mounted tray is available.

Pressure adaptor fittings

Customized calibration systems



LEAN
CLEAN
GREEN

Mensor is dedicated to manufacturing quality products in a "Lean, Clean and Green" environment. All of our processes are regularly evaluated to promote continuous improvement. Kaizen events, 5S, and SQDC boards are used on a regular basis to promote lean manufacturing. Our 5S program is called "5S plus". The traditional 5S program represents Sort, Set, Shine, Standardize and Sustain, where "5S plus" includes Safety. We have containers designated to recycle paper, metal, electronics and cardboard. Waste is recycled to do our part in keeping our environment green.

Scope of supply

- CPC3000 High-Speed Pressure Controller
(Desk top version with bezel and handle)
- Power cable (6 ft.) with plug
- Operating instructions
- NIST traceable calibration certificate
- Pressure adaptor fittings
- A2LA certificate

Options

- Barometric reference
- 19" rack mounting kit
- Customized calibration system

Accessories

- ④ Additional pressure adaptor fittings

All standard Mensor products are provided with a calibration certificate traceable to NIST. The calibration program at Mensor is accredited to both ISO/IEC 17025:2005 and Z540-1-1994 by A2LA. Mensor is certified to ISO9001:2008.
©2007 Mensor.



Specifications and dimensions given in this leaflet represent the state of engineering at the time of printing. Modifications may take place and materials specified may be replaced by others without prior notice.