

Wet Bulb Thermo-Hygrometer Datalogger

Plus Dew Point Temperature

Model WB200

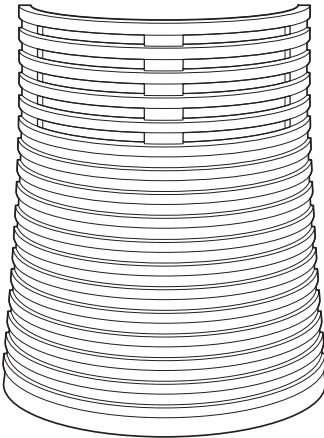
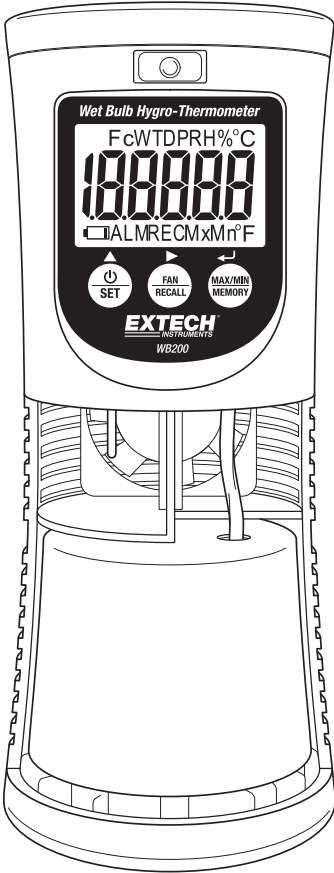

Introduction

Thank you for selecting the Extech Instruments WB200 Thermo-Hygrometer Datalogger with Dew Point and Wet Bulb Temperature readings. This device measures and displays four (4) environmental parameters: Air Temperature, % Relative Humidity, Wet Bulb Temperature, and Dew Point Temperature. This meter combines traditional dry/wet bulb operation with modern electronic circuitry to provide accurate readings and trouble-free operation especially in dusty environments.

The built-in datalogger, with selectable sampling rate, captures up to 100 readings for each measurement type. The stored readings can be viewed on the meter's LCD display.

The WB200 is perfect for greenhouses, other high humidity areas, and locations prone to harsh environmental conditions.

This device is shipped fully tested and calibrated and, with proper use, will provide years of reliable service. Extech Instruments is an ISO-9001 certified company. Check the Extech website (www.extech.com) to check for newer versions of this User Guide.

Features

- Large easy-to-read LCD display
- Two thermistors provide fast, accurate readings
- Built-in fan quickens response time
- Fan can be set to run continuously or in the 'economical' mode where it throttles on and off
- Datalogger stores 100 records (each record contains 4 measurement types)
- Selectable datalogging sampling rate from 15 minutes to 60 minutes
- Temperature and humidity high/low alarms (fully programmable)
- Dual color LED indicator for datalogging (green) and alarm (red) modes
- Maximum/Minimum function shows highest and lowest readings
- Selectable temperature units °C/°F
- Low battery indicator

Powering the Meter

The WB200 can be powered using the four (4) supplied 1.5V batteries (AAA) or the supplied 5V power adaptor; the adaptor is recommended for extended measurement sessions. When the low battery icon appears replace the batteries promptly, the battery compartment is located on the bottom of the meter. Please refer to the Battery Replacement section of this guide for more information.

Mounting the Meter

The meter can be placed on any surface or may be suspended by wire or string using the two mounting holes at the top of the meter (one on either side of meter top). If the meter is to be kept on a table top, work bench, or desktop surface take great care to avoid having the meter fall over on its side (this may spill the contents of the water tank and may interfere with the operation of the fan). Suspension is the preferred method of mounting since the meter is unlikely to fall over while suspended.

Meter Description

1. Hang-mount attachment holes
2. LED status indicator
3. LCD Display
4. Push-button keypad
5. Thermistor sensor
6. Fan
7. Wet Bulb wick covering thermistor
8. Water tank
9. Battery compartment (bottom of meter)
10. Removable protective cover

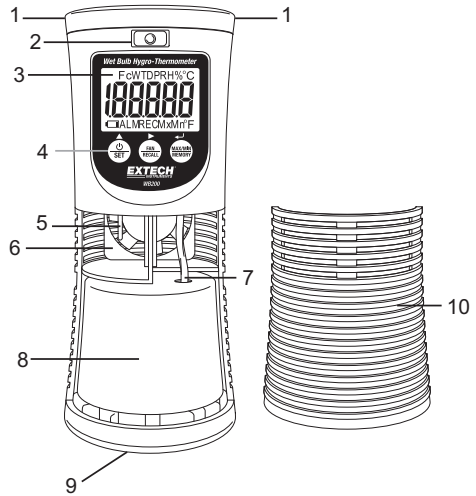

Not Pictured: Power Adaptor port (on rear side)

LCD Display Description

Fc: Full Content (internal datalogging memory is full)

RH%: Percent Relative Humidity

°C/°F: Selectable temperature units of measure

ALM: Alarm condition

REC: Recording (datalogging) mode

Mx: Maximum reading

Mn: Minimum reading

WT: Wet Bulb temperature

DP: Dew Point temperature

: Low Battery icon

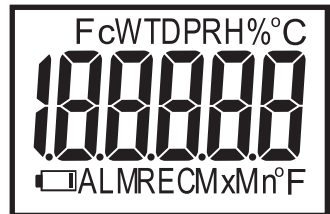

Keypad Description

POWER / SET / UP ARROW KEY (▲)

- Switches the meter ON and OFF
- Press and hold for at least 2 seconds to enter the set-up mode
- The ▲ key is used during set-up and other programming operations for stepping and editing



FAN / RECALL / RIGHT ARROW KEY (▶)

- Switches the fan ON
- Press and hold for at least 2 seconds to review (recall) stored datalogger data
- The ▶ key selects a digit in the set-up mode while editing

MAX / MIN / MEMORY / ENTER (↵) KEY

- Displays the Maximum (MAX) and Minimum (MIN) readings for a measurement session
- Press and hold for at least 2 seconds to start datalogging to the meter's internal memory
- Used as an ENTER key in set-up mode for stepping and editing

Operation

Getting started

Momentarily, press the Power button  to switch the meter ON.

After the 3-second power-up self-test, the meter switches to the normal measurement mode where the Air Temperature, % Relative Humidity, Wet Bulb Temperature, and Dew point Temperature readings cycle automatically every two seconds on the LCD (refer to Figure 1 below).

Figure 1 - Four Measurement Modes Display Cycling

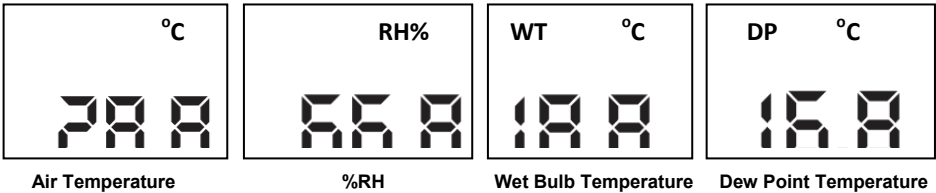

The meter runs the fan for 2 minutes upon power-up to generate readings; the meter only updates readings while the fan is running.

Switching the Fan ON

As mentioned, the meter takes measurements only while the fan is running. When the meter is not in the “CON” (continuous fan) mode, press the FAN button to start the fan and view current measurements; the fan will run for 2 minutes with each button press. When the environmental conditions change, run the fan to quicken the response time and to obtain the latest readings. To access the CON (continuous) fan feature, refer to the SETUP mode section of this guide.

Maximum (MAX) and Minimum (MIN) Readings

The meter begins storing the maximum and minimum readings for air temperature, % relative humidity, dew point temperature, and wet bulb temperature when the meter is switched ON. When the meter is switched OFF, the MAX and MIN readings are cleared.

To view the maximum readings, press the MAX/MIN key once. The meter will now cycle through the four (4) measurement modes presenting the highest reading encountered since power-up for each. Note that the Mx icon will be displayed at the bottom of the LCD.

To view the minimum readings, press the MAX/MIN key again (from the MAX mode). The meter will now cycle through the four (4) measurement modes again, presenting the lowest reading encountered since power-up for each. Note that the Mn icon will be displayed. To return to the normal measurement mode, press the MAX/MIN key again. The Mx and Mn icons are switched OFF in the normal measurement mode. Refer to Figure 2 below.

Figure 2 – Maximum (Mx) and Minimum (Mn) Display Modes

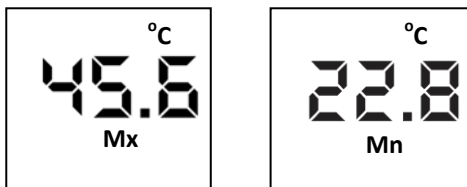

Alarm Mode

The WB200 features High and Low temperature and humidity Alarms that alert the user when a reading has exceeded a programmed limit for 30 seconds. The alert switches off when a reading returns to normal for 30 seconds. Refer to SETUP section for details on setting alarm thresholds.

When alarming, the LED (located above the LCD) flashes RED and the beeper sounds. After alarming for 1 minute, the beeper silences but the red LED continues to flash at a slower rate (the meter display also flashes the ALM icon at the same rate as the flashing red LED).

Users can manually silence the beeper by pressing and holding any key for 2 seconds (while the beeper is sounding). The flashing LED, however, will not cease until the readings return to a normal range.

Datalogger Mode

The WB200 automatically records data for all four measurement types at a user-programmable sampling rate (programmable from 15 minutes to 60 minutes in 5 minute increments). The meter's internal memory capacity is 100 records (each record has four readings, one for each measurement type). Refer to the SETUP section of this guide for details on programming the sampling rate.

1. Press and hold the MEMO (memory) key for 2 seconds to start datalogging. The display will show the START icon as the meter begins recording. The REC icon will flash on the display for the duration of the datalogging session. Refer to Figure 3 below.

Figure 3 - Datalogger display examples

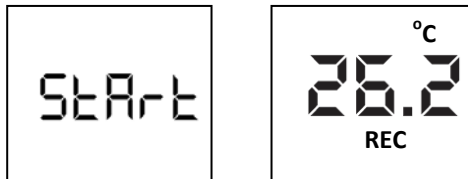

2. When the meter's internal memory is full (100 records), the display will show the Fc icon (full content) and datalogging will cease. When the memory is cleared (detailed below), the Fc indicator switches OFF.
3. To view the stored readings press and hold the RECALL key for 2 seconds. The display will indicate the letter 'r' for reading (on the left side), followed by a number, on the right side, that represents the memory location of the stored reading (1 to 100). The meter will then cycle through the readings stored at that location. Use the up arrow key to navigate the memory locations.
4. Press and hold the ENTER key (↵) for 2 seconds while in the RECALL mode to delete all stored readings. Dashes on the display indicate that the memory has been cleared.
5. Press and hold the RECALL key again for 2 seconds to exit the RECALL mode. Note that the meter will automatically exit the recall mode and enter the normal measurement mode after 30 seconds of keypad inactivity.

Switching the Temperature Units of Measure (°C/°F)

In the normal measurement mode of operation, and with the air temperature display shown, momentarily press the SET and RECALL buttons simultaneously to switch the unit of measure (°C to °F or vice versa).

Setup Mode

SETUP Mode Overview

In the set-up mode, the user can customize the functionality of the meter.

To access the set-up mode, press and hold the SET key for 2 seconds.

Once in the set-up mode, use the ENTER (↵) key to step through the four (4) available parameter icons and use the up arrow key to change a setting. Each parameter is explained below:

- ALARM MODE TEMPERATURE (Displayed as **t. ON/OFF**): High and Low Temp. Alarms
- ALARM MODE RH (displayed as **rh. ON/OFF**): High and Low Relative Humidity Alarms
- SAMPLING RATE (displays as **15 to 60** minutes): Sampling interval (rate) for Datalogger
- FAN MODE: (displays as **ECO or CON**): Economical (ECO) / Continuous (CON)

Note that the meter switches from the set-up mode to the normal operating mode after 10 seconds of keypad inactivity. To complete a session, be sure to proceed to the end of the sequence to properly store the settings.

Editing in the SETUP Mode

Each parameter is explained below and steps are provided for making and saving changes.

1. Temperature Alarm Mode – (t.ON/OFF)

In the Temperature Alarm mode the user can set the alarms ON or OFF and set the High and Low Alarm Limit values. When these limits are exceeded, the meter audibly and visibly (red flashing LED) alerts the user. Refer to the Operation section of this guide for more details on alarm alerts.

- a. Press and hold the SET key for 2 seconds to enter the set-up mode. The first parameter is t.ON or t.OFF.
- b. Use the ▲ key to set the temperature alarms ON.
- c. With the display showing t.ON, press the ENTER (↵) key to access the HI or LO Alarm Limit. Use the ▲ key to select HI (if necessary).
- d. Press ENTER (↵) again to access the HI Limit adjustment screen. The adjustment range for the HI limit is 1.0°C to 49.9°C or 33.8°F to 121.9°F.
- e. The flashing digit on the Alarm Limit adjustment screen is ready to be changed; use the ▲ key to adjust it as desired. Use the ► key to select another digit for editing.
- f. When finished programming a HI Limit, press ENTER (↵) to program the LO Alarm Limit (in the same fashion as the HI Alarm). Note that the LO limit cannot be set higher than 1°C or 1.8°F below the HI Limit.
- g. When finished, press ENTER (↵) to access the next parameter:

2. Relative Humidity Alarm Mode – (rh.ON/OFF)

In the RH Alarm mode the user can set the alarms ON or OFF and set the High and Low Alarm Limit values. When the limits are exceeded, the meter audibly and visibly (red flashing LED) alerts the user. Refer to the Operation section of this guide for more details on alarm alerts.

- a. When the temperature alarm parameters are set as described above and the user presses the ENTER (↵) key to continue, the rh.ON/OFF screen appears. Use the ▲ key to change to rh.ON if necessary and then press ENTER (↵) to access the Alarm Limit section. If necessary, use the ▲ key to select HI.
- b. With HI displayed, press ENTER (↵) to access the HI Limit adjustment screen. The adjustment range for the HI limit is 3.0 to 99.9%RH.
- c. The flashing digit on the HI Alarm Limit adjustment screen is ready to be changed; use the ▲ key to adjust it as desired. Use the ► key to select another digit for editing. When finished, press Enter (↵) to access and program the LO Alarm Limit in the same fashion as the HI Alarm (the LO limit cannot be set higher than 3% below the HI Limit).
- d. When finished programming the Alarm Limits, press ENTER (↵) to access the next set-up parameter:

3. Sampling Rate for Datalogger (select up to a 60 minute interval)

The meter's internal memory can store up to 100 sets of readings (each set includes one measurement from each of the four available measurement modes).

The datalogger automatically stores a set of readings at a programmed interval (sampling rate). The user can select a sampling rate from 15 to 60 minutes in 5 minute increments.

- a. With the display showing the currently selected sampling rate, use the ▲ key to select the desired rate at which the datalogger will store readings.
- b. Press ENTER (↵) when finished to access the next SETUP mode parameter:

4. Fan Mode: Economical (ECO) or Continuous (CON)

The meter's fan can be set to the continuously running mode (CON) or for economical mode (ECO) where the fan runs periodically (and where the user can manually press the FAN button to run the fan for 2 minutes at a time). Note, as mentioned earlier, that the meter only updates the displayed readings when the fan is running.

- a. With ECO or CON displayed, use the ▲ key to select the desired mode
- b. When finished, press ENTER (↵) to return to the normal operation mode
- c. Setup is now complete

Troubleshooting

For unusually high humidity readings, check the condition of the cotton wick immersed in the water bottle. Ensure that the cotton wick is kept moist and the water bottle is 80% full.

Displayed Error Codes

- E2** Under range temperature reading (measurement is outside the capability of this device)
- E3** Over range temperature reading
- E4** Internal component failure (return unit for service)
- E5** Algorithm error causing relative humidity measurement inaccuracy (return for service)
- E33** Humidity measurement circuit damage (return for service)

Battery Replacement

When the battery icon appears empty  on the LCD, the batteries must be replaced. Please remove the water tank before replacing the batteries and replace it afterward.



- Remove the water tank cover using the meter's side tabs, and remove the water tank.
- The battery compartment is located at the bottom of the meter. Three Philips head screws provide access. Use care when removing the screws as they each include a rubber grommet for protection against moisture and should not be discarded or lost.
- Replace the four (4) 1.5V 'AAA' batteries observing polarity.
- Replace the battery cover and water tank before operating the meter. Ensure that the cotton wick is immersed in the water bottle and that the meter housing is closed before operating the meter.

Please dispose of batteries responsibly; always observe local, state, and federal regulations with regard to battery disposal.

Water Tank Refilling

1. Open the water tank cover by first gripping the meter with one hand and prying the cover off with the other (pulling forward on the meter's two side tabs).
2. Remove the water tank from the meter and then remove the tank's stopper.
3. Refill the water tank to 80% full.
4. Replace the tank's stopper, place the water tank inside the meter, and place the cotton wick into the water tank. Note that the wick can be inserted partially into the tank before the water tank is inserted into the meter; once the water tank is inserted into the meter, the wick can then be fed further into the tank more easily.
5. Reassemble the meter.
6. Notes on Tank Refilling:
 - The water tank is used for web bulb temperature measurements.
 - To avoid spillage, do not tilt the meter during operation.
 - Refill the tank every 2 to 3 weeks for best results.

Specifications

LCD Display	7-segment digit type for readings and messages Function icons above and below reading for units and mode status Low battery indication 
LED status indicator	Flashes red in an Alarm condition Flashes green when a reading is logged
Audible Alert	Sounds intermittently when in an Alarm condition
Response time	120 second update rate
Temperature Units	Switchable Temperature units (°C/°F)
Measurement ranges	Temperature (air, wet bulb, dew point): 41 to 122°F (5 to 50°C) Relative Humidity: 0.0 to 99.9%
Resolution	0.1°C/F (air, dew point, and wet bulb temperature) 0.1% Relative Humidity
Accuracy	RH: ± 3% (10 to 90%RH @ 25°C; ± 5% outside of this range) Air, Dew Point, and Wet Bulb Temperature: ± 1°F (0.6°C)
Datalogger memory	Up to 100 reading sets (each set includes one measurement from each of the four measurement modes). Recall readings directly on the meter's LCD display. The internal memory is non-volatile.
Datalogging sample rate	Programmable from 15 to 60 minutes in 5 minute increments
Over range indication	"E3" appears on the LCD
Under range indication	"E2" appears on the LCD
Low battery indication	Empty battery symbol appears on the LCD ()
Power supply	Four (4) 1.5V 'AAA' batteries or 5V universal power adaptor (included)
LCD Dimensions	0.94(H) x 1.58" (W) / (24 x 40 mm)
Meter Dimensions	2.8 (top cover) x 3.1 (bottom cover) x 7.0 (H)" (70.8 x 77.6 x 177mm)
Weight	8.0 oz. (250g) with batteries

Copyright © 2012 Extech Instruments Corporation (a FLIR company)

All rights reserved including the right of reproduction in whole or in part in any form

Warranty

EXTECH INSTRUMENTS CORPORATION (a FLIR company) warrants this instrument to be free of defects in parts and workmanship for **one year** from date of shipment (a six month limited warranty applies to sensors and cables). If it should become necessary to return the instrument for service during or beyond the warranty period, contact the Customer Service Department for authorization. Visit our website www.extech.com for contact information. A Return Authorization (RA) number must be issued before any product is returned to Extech. The sender is responsible for shipping charges, freight, insurance and proper packaging to prevent damage in transit. This warranty does not apply to defects resulting from action of the user such as misuse, improper wiring, operation outside of specification, improper maintenance or repair, or unauthorized modification. Extech specifically disclaims any implied warranties or merchantability or fitness for a specific purpose and will not be liable for any direct, indirect, incidental or consequential damages. Extech's total liability is limited to repair or replacement of the product. The warranty set forth above is inclusive and no other warranty, whether written or oral, is expressed or implied.

Calibration and Repair Services

Extech offers repair and calibration services for the products we sell. Extech also provides NIST certification for most products. Call the Customer Service Department for information on calibration services available for this product. Extech recommends that annual calibrations be performed to verify meter performance and accuracy.

Support lines: U.S. 877-439-8324, Intl. +1 603-324-7800

Technical support: Option 3; E-mail: support@extech.com

Repair & Returns: Option 4; E-mail: repair@extech.com

Product specifications subject to change without notice

Visit our website: www.extech.com

Extech Instruments Corporation, 9 Townsend West, Nashua, NH 03063

ISO 9001 Certified since 1995

Garantie

EXTECH INSTRUMENTS CORPORATION (une société FLIR) garantit que cet instrument est exempt de défectuosité ou de défaut de fabrication pendant une période d'un an à compter de la date de livraison (une garantie limitée de six mois est applicable pour les sondes et les câbles). S'il s'avère nécessaire de retourner l'instrument pour un dépannage durant ou après la période de garantie, contactez le service à la clientèle pour obtenir une autorisation de retour. Visitez notre site Web au www.extech.com pour des informations. Un numéro d'autorisation de retour (AR) doit être émis avant que tout produit puisse être retourné à Extech. L'expéditeur est responsable des frais d'expédition, de transport, d'assurance et d'emballage adéquat afin de prévenir les dommages durant le transit. Cette garantie ne s'applique pas aux défauts résultant d'une action de l'utilisateur tels un mauvais usage, un câblage adéquat, un fonctionnement hors des spécifications, un entretien ou un dépannage inadéquat, ou une modification non autorisée. Extech décline précisément toute garantie implicite ou garantie marchande ou d'adaptation à un usage particulier et ne pourra être tenu responsable d'aucun dommage direct, indirect, accidentel ou consécutif. La responsabilité totale d'Extech se limite à la réparation ou au remplacement du produit. La garantie énoncée ci-dessus est inclusive et aucune autre garantie, qu'elle soit écrite ou orale, n'est stipulée ou sous-entendue.

Service de calibrage et de réparation

Extech offre un service de calibrage et de réparation pour toute sa gamme de produits. Extech fournit également une certification NIST pour la plupart de ses produits. Contactez le Service Clients pour de plus amples informations concernant les services de calibrage disponibles pour ce produit. Extech vous recommande de procéder à un test de calibrage annuel afin de vérifier régulièrement les performances et la précision de votre appareil.

Appui de produit U.S. 877-439-8324, Intl. +1 603-324-7800

Service d'assistance technique: l'option 3, email : support@extech.com

Réparations et retours : l'option 4, email : repair@extech.com

Spécifications produit sujettes à modifications sans préavis

www.extech.com

Extech Instruments Corporation, 9 Townsend West, Nashua, NH 03063

ISO 9001 Certified since 1995

Garantía

EXTECH INSTRUMENTS CORPORATION (una empresa FLIR) garantiza este instrumento libre de defectos en partes o mano de obra durante **un año** a partir de la fecha de embarque (se aplica una garantía limitada a seis meses para los cables y sensores). Si fuera necesario regresar el instrumento para servicio durante o después del periodo de garantía, llame al Departamento de Servicio a Clientes para autorización. Visite nuestra página en Internet www.extech.com para Información de contacto. Se debe otorgar un número de Autorización de Retorno (RA) antes de regresar cualquier producto a Extech. El remitente es responsable de los gastos de embarque, flete, seguro y empaque apropiado para prevenir daños en tránsito. Esta garantía no se aplica a defectos resultantes de las acciones del usuario como el mal uso, alambrado equivocado, operación fuera de las especificaciones, mantenimiento o reparación inadecuada o modificación no autorizada. Extech específicamente rechaza cualesquier garantías implícitas o factibilidad de comercialización o aptitud para cualquier propósito determinado y no será responsable por cualesquier daños directos, indirectos, incidentales o consecuentes. La responsabilidad total de Extech está limitada a la reparación o reemplazo del producto. La garantía precedente es inclusiva y no hay otra garantía ya sea escrita u oral, expresa o implícita.

Servicios de reparación y calibración

Extech ofrece servicios completos de reparación y calibración para todos los productos que vendemos. Extech además provee certificación NIST para la mayoría de los productos. Llame al Departamento de Servicio al Cliente para solicitar información de calibración para este producto. Extech recomienda realizar calibraciones anuales para verificar el desempeño y precisión del medidor.

Ayuda de producto: U.S. 877-439-8324, Intl. +1 603-324-7800

Soporte Técnico Opción 3, e-mail support@extech.com

Reparación / Retornos: Opción 4, e-mail repair@extech.com

Las especificaciones del producto están sujetas a cambios sin aviso

Visite nuestro sitio web www.extech.com

Extech Instruments Corporation, 9 Townsend West, Nashua, NH 03063

ISO 9001 Certified since 1995