

# User's Guide

# **EXTECH** INSTRUMENTS

## 1000A 3-Phase Power Analyzer/Datalogger

Model 382090 (60Hz)

Model 382091 (50Hz)

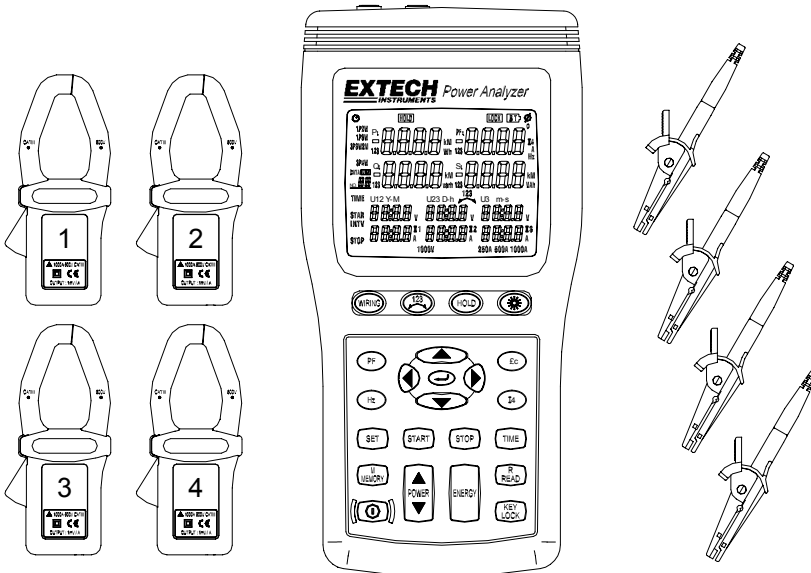

## Warranty

---

EXTECH INSTRUMENTS CORPORATION warrants this instrument to be free of defects in parts and workmanship for one year from date of shipment (a six month limited warranty applies to sensors and cables). If it should become necessary to return the instrument for service during or beyond the warranty period, contact the Customer Service Department at (781) 890-7440 ext. 210 for authorization or visit our website [www.extech.com](http://www.extech.com) for contact information. A Return Authorization (RA) number must be issued before any product is returned to Extech. The sender is responsible for shipping charges, freight, insurance and proper packaging to prevent damage in transit. This warranty does not apply to defects resulting from action of the user such as misuse, improper wiring, operation outside of specification, improper maintenance or repair, or unauthorized modification. Extech specifically disclaims any implied warranties or merchantability or fitness for a specific purpose and will not be liable for any direct, indirect, incidental or consequential damages. Extech's total liability is limited to repair or replacement of the product. The warranty set forth above is inclusive and no other warranty, whether written or oral, is expressed or implied.

## Introduction

---

Congratulations on your purchase of the Extech 382090/382091 1000A 3-Phase Power Analyzer Datalogger. Model 382090 is for use with 60Hz power systems. Model 382091 is for use with 50Hz power systems. This package includes four (4) clamp-on meters and four (4) alligator clip leads that connect to the analyzer/datalogger. When the clamps and test leads are connected to the circuit under test the user can view up to ten power measurement displays. Also, up to 20,000 data sets can be automatically stored by the analyzer/datalogger. Stored readings can later be transferred to a PC. Real-time logging (readings recorded and transferred to PC at the same time) is also supported. Careful use of these instruments will provide years of reliable service.

### Features

- Ten display LCD screens capable of showing a multitude of power quality parameters simultaneously
- Up to four current probes can be connected to the analyzer
- Measure single-phase 2-wire, single-phase 3-wire, three-phase 3-wire and three-phase 4-wire systems
- True-RMS sensing for V, A, KW, KVAR, KVA, PF,  $\theta$ , Hz, KWh, KVARh and KVAh measurements
- Phase sequence indicator
- Backlit display
- Manual and Automatic Datalogging
- PC interface with 3-phase voltage/current waveform display & harmonic analysis
- Easy-to-use push-button operation
- Light weight and portable

# Safety

---

This Operation Manual provides information and warnings essential for operating the Model 382090/382091 in a safe manner. Before using this meter, be sure to carefully read the following safety information.



## DANGER

During high voltage measurements, incorrect measurement procedures could result in injury or death, as well as damage to the meter. Please read this manual carefully and be sure to understand its contents before using the meter.

- Do not use the meter if the test leads appear damaged
- Use extreme caution when working around bare conductors or bus bars, Accidental contact with the conductor could result in electric shock
- To avoid damage to the meter do not exceed the specified maximum input limits
- Use the meter only as specified in this manual to ensure that the protection provided by the meter is not impaired

### SAFETY SYMBOLS



This symbol printed on the meter alerts the operator to consult corresponding manual topics before using related meter functions



Dangerous voltages



Meter is protected throughout by double insulation or reinforced insulation. When servicing, use only specified replacement parts.



Complies with EN-61010-1, IEC 1010-2-32



**DANGER:** Indicates that incorrect operation presents extreme danger of accident resulting in death or serious injury to the user.



**WARNING:** Indicates that incorrect operation presents significant danger of accident resulting in death or serious injury to the user.



**CAUTION:** Indicates that incorrect operation presents possibility of injury to the user or damage to the meter.

**NOTE:** Denotes items of advice related to the performance of the meter or to its correct operation.

## Installation Safety



### CAUTION

- The meter is designed for indoor use and can be safely used at temperatures ranging from 32 to 122°F (0 to 50°C).
- Do not store or use the meter where it will be exposed to direct sunlight, high temperature, high humidity, or condensation. If exposed to such conditions, the meter may be damaged, the insulation may deteriorate, and/or the meter may no longer meet the published specifications.
- The meter is not waterproof or dustproof
- Do not use the unit where it may be exposed to corrosive or explosive gases

## Preparation Safety



### WARNING

- To prevent electrical shock, do not allow the meter to become wet and do not handle the meter with wet hands.
- When working with live circuits, take all suitable precautions against accidents, including the use of electrical safety gear such as rubber gloves, rubber boots, and safety helmets.

## Connection Safety



### WARNING

- To prevent electrical shock, turn the power off before connecting the test leads.
- In order to prevent electrical shock and short-circuits, shut off the power to the line under test before connecting the line under test to the voltage input terminals.



### CAUTION

The measurement input and synchronizing input are not isolated from each other. Connecting either one means that the other is exposed and live with a danger of electrical shock present. To avoid electrical shock, connect both terminals.











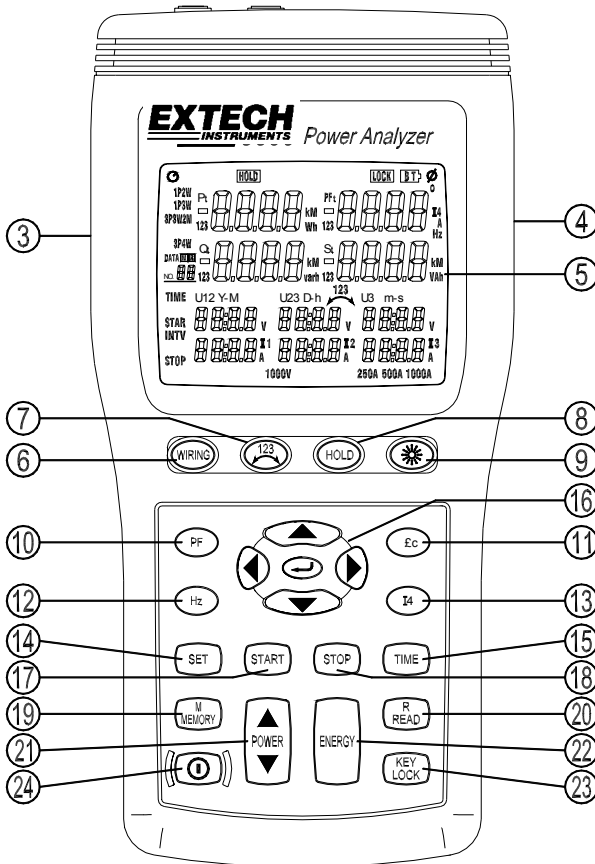
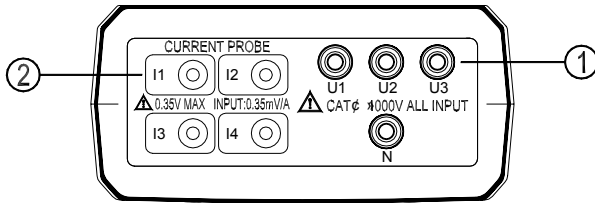



### WARNING

To avoid electrical shock and/or meter damage, use caution when connecting test leads to live components. The jaws of alligator clips can create a short circuit between closely spaced live parts. Avoid making connections to feeder conductors or bus bars at elevated potentials.

- Follow all city, state, and local codes. Obey posted instructions.
- Never assume that a circuit is de-energized, check it first.
- Always set up the measurement first and then connect test leads to the circuit.
- Make connections to the meter first, before connecting leads to a live circuit.
- Connect the ground lead first, then the voltage leads and the current probe. Disconnect in reverse order.

# Analyzer Description



1. **Input jacks for test leads (U1, U2, U3, N)**
2. **Input jacks for current probes (I1, I2, I3, I4)**
3. **Plug for external AC adaptor**
4. **Optical RS232 PC interface output**
5. **LCD display**
6. **WIRING key** Select the type of electrical system under test using the WIRING key.  
Select 1P2W (for signal-phase two-wire power lines), 1P3W (for signal-phase three-wire power lines), 3P3W2M (for three-phase three-wire power line without neutral using the two power meter method; use this selection when measuring three-phase power with 2-current probe measurement only) and 3P4W (for three-phase four-wire power lines with neutral)
7.  **key** Phase sequence detection function key. In the 3P4W mode, press and hold this key to display the phase detection results as follows:  
  
Normal phase   
  
Reverse phase 
8. **HOLD key** Data hold function key, press HOLD key to freeze displayed reading (the  icon will appear). Press HOLD again to exit Hold function.
9.  **key** Backlight function key, press to turn backlight on or off. The backlight will switch off automatically after 30 seconds.
10. **PF key** Press to view the power factor value (the PF icon is displayed)
11.  **key** Press to view the measured phase angle value ( $\psi$  icon is displayed)
12. **Hz key** Press to display the measured frequency (the Hz icon is displayed)
13. **I4 key** Press to display the I4 current probe value (the I4 icon is displayed)
14. **SET key** Press and hold the TIME key then press the SET key to enter the time set mode and datalogger sampling rate set mode
15. **TIME key** Press to display the current date and time
16.  Used when setting the date and time. Also used to recall manually recorded data
17. **START key** Press to start the automatic datalogging function
18. **STOP key** Press to stop/pause the automatic datalogging function. Press START to resume recording.
19. **MEMORY** Press key to store one reading (set), the 'M' icon and the memory address will display (total manual memory size is 99 sets)
20. **READ key** Press to recall a manually stored data set
21.  **POWER**  Press to display the measured power. Use this button to cycle through the Pt123, Qt123 and St123 displays
22. **ENERGY** Press to display the total integrated power energy
23. **KEY Lock** Press to lock all of the keys except the  and  keys
24.  **key** Power on-off key

# Display Description

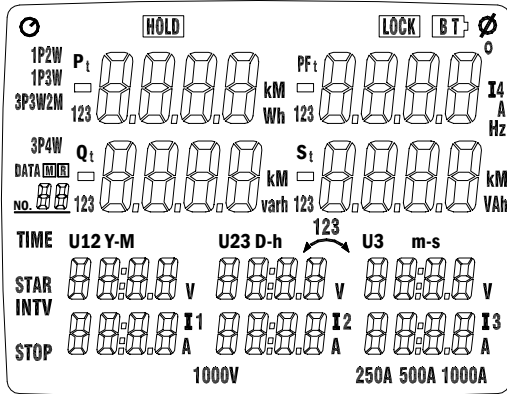

⊙ : Auto power off indicator

**HOLD** : Display hold mode

**LOCK** : Lock-out mode

**BT** : Low battery indication

ψ: Phase angle display

◦ : Phase angle unit of measure (degrees)

**1P2W**: Single-phase two-wire power line indicator

**1P3W**: Single-phase three-wire power line indicator

**3P3W2M**: Three-phase three-wire power line indicator

**3P4W**: Three-phase four-wire power line indicator

**P1**: Phase 1 active power indicator

**P2**: Phase 2 active power indicator

**P3**: Phase 3 active power indicator

**Pt**: Total active power indicator and total active energy indicator

**KW**: Active power unit of measure (kilo-watt)

**KWh, MWh**: Active energy units of measure (kilo-watt hours and Mega-watt hours)

**PF1**: Phase 1 power factor indicator

**PF2**: Phase 2 power factor indicator

**PF3**: Phase 3 power factor indicator

**PFt**: Total power factor indicator

**I4**: Current probe No. 4 measurement indicator

**Hz**: Frequency unit of measure (hertz)

**DATA No.xx**: Manually datalogged memory address (01~99)

**M** : Datalog record indicator; **M** displays momentarily each time a data set is recorded

**DATA R No.xx**: Memory address for recalled reading

**DATA M xx**: Auto datalogging indicator; **M** flashes each time a data set is recorded.

01 ~ 10: Memory blocks (20,000 max. data sets can be stored)

FF: Memory full indicator (when 10 memory blocks or 20,000 readings are filled)

**Q1:** Phase 1 reactive power indicator  
**Q2:** Phase 2 reactive power indicator  
**Q3:** Phase 3 reactive power indicator  
**Qt:** Total reactive power indicator and total reactive energy indicator  
**Kvar:** Reactive power unit of measure  
**Kvarh, Mvarh:** Reactive energy unit of measure  
**S1:** Phase 1 apparent power indicator  
**S2:** Phase 2 apparent power indicator  
**S3:** Phase 3 apparent power indicator  
**St:** Total apparent power indicator and total apparent energy indicator  
**KVA:** Apparent power unit of measure (Kilo-volt/amps)  
**KVAh:** Apparent energy unit of measure (kilo-volt amp hours)  
**MVAh:** Apparent energy unit of measure (mega-volt amp hours)  
**TIME:** Current date and time indication  
**Y-M D-h m-s:** Date and time  
**INTV:** Automatic datalogging sampling interval setting indicator  
**START:** Energy calculation start-time indicator  
**STOP:** Energy calculation stop-time indicator  
**U1, V, A:** Single-phase two-wire (1P2W) U1 voltage and I1 current measurement  
**U1, V, A, U2, V, A:** Single-phase three-wire (1P3W) U1, U2 voltage and I1, I2 current measurement  
**U12, V, I1, A, U23, V, I2, A:** Three-phase, three-wire, two-power method (3P3W2M);  
U12, U23 voltage and I1, I2 current measurement  
**U1, V, A, U2, V, A, U3, V, A:** Three-phase, four-wire (3P4W) U1, U2, U3 voltage and I1,  
I2, I3 current measurement  
**V:** Voltage unit of measure  
**A:** Current unit of measure (ampere)  
**1000V:** Voltage range indication  
**250A, 500A, 1000A:** Current range indication (Autoranging)



## Operation



CAUTION: Turn the meter off before connecting to the equipment under test.



DANGER: Voltage input connectors U1 to U3 are common to input connector N. Input connectors are not insulated; remove all unnecessary test leads.



### WARNINGS

- Always set up the measurement first and then connect the test leads to the circuit.
- Make connections to the instrument first, before connecting leads to a live circuit.
- Connect the ground lead first and then the voltage leads and current probe; disconnect in reverse order.
- Remove all test leads that are not in use.

### Single-Phase 2-Wire (1P2W) Power System Measurement

U1 must be connected to the voltage source during the measurement of U2, U3, I1, I2 and I3 since U1 is the main signal source for the entire meter measurement system.

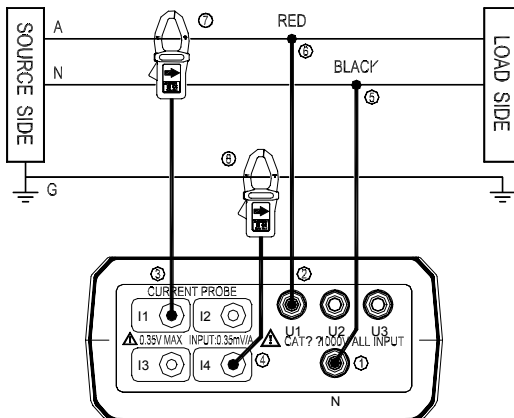

A: Line, N: Neutral, G: Ground; Face the arrow toward the load.

### 1P2W Wiring Connection Diagram

1. Press key to turn the meter on
2. Press the WIRING key to select 1P2W, the 1P2W annunciator will be displayed.
3. Connect the voltage test leads and current probe to the meter.
  - ① Connect the black voltage test lead to the "N" terminal.
  - ② Connect the red voltage test lead to the "U1" terminal.
  - ③ Connect the I1 current probe output plug to the "I1" jack.
  - ④ To measure ground leakage current, connect the I4 current probe output plug to the "I4" jack.

4. Connect the voltage test leads and current probe to the electrical equipment under test.



CAUTION: Turn the meter off before connecting the voltage test leads and the current probe to the electrical equipment under test.

- ⑤ Connect the black voltage alligator clip to the Neutral Line “N”.
  - ⑥ Connect the red voltage alligator clip to Line “A”.
  - ⑦ Press the I1 current probe trigger to open the jaw and then fully enclose Line “A”.
  - ⑧ To measure ground leakage current, press the I4 current probe trigger to open the jaw and then fully enclose the Ground Line “G”.
5. To measure frequency, press the “Hz” key.  
To measure the phase angle, press the “ $\Theta$ ” key.  
To measure the ground leakage current, press the “I4” key.  
To measure the power factor, press the “PF” key.
6. To measure energy, press the “ENERGY” key, the “Pt”, “Qt”, “St” and “PFt” or “ $\Psi$ t” annunciators and energy integration start time will display.  
The energy integration value and the current time will continually update. Press the “ $\_$ ” key to pause the energy calculation; the **HOLD** annunciator will display. Press the HOLD key to exit the energy measurement mode.

## Single-Phase 3-Wire (1P3W) Power System Measurement

U1 must be connected to the voltage source during the measurement of U2, U3, I1, I2 and I3 since U1 is the main signal source for the entire meter measuring system.

A, B: Line, N: Neutral, G: Ground;  Face the arrow toward the load.

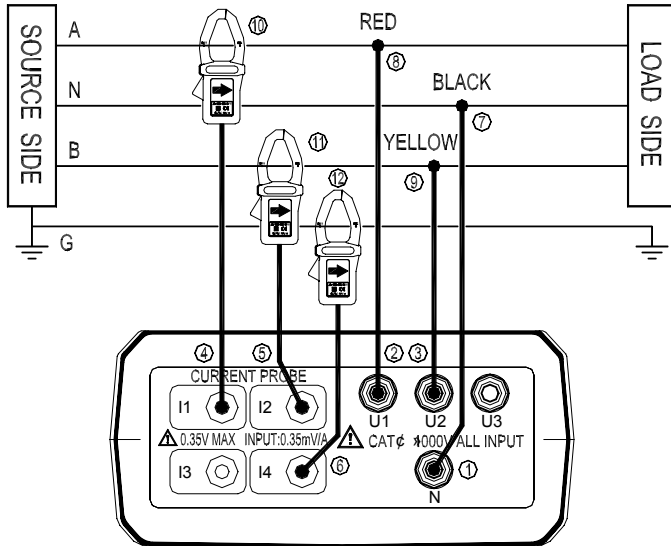

**1P3W Wiring Connection Diagram**

1. Press the  key to turn the meter on
2. Press the WIRING key to select 1P3W, the 1P3W annunciator will display.
3. Connect the voltage test leads and the current probe to the meter.
  - ① Connect the black voltage test lead to the "N" terminal.
  - ② Connect the red voltage test lead to the "U1" terminal.
  - ③ Connect the yellow voltage test lead to the "U2" terminal.
  - ④ Connect the I1 current probe output plug to the "I1" jack.
  - ⑤ Connect the I2 current probe output plug to the "I2" jack.
  - ⑥ To measure ground leakage, connect the I4 current probe output plug to the "I4" jack.
4. Connect the voltage leads and current probe to the electrical equipment to be tested.



**CAUTION:** Turn the meter off before connecting the voltage test leads and the current probe to the electrical equipment under test.

- ⑦ Connect the black voltage alligator clip to the neutral line "N".
- ⑧ Connect the red voltage alligator clip to line "A".
- ⑨ Connect the yellow voltage alligator clip to line "B".
- ⑩ Press the I1 current probe trigger to open the jaw and then fully enclose Line "A".
- ⑪ Press the I2 current probe trigger to open the jaw and then fully enclose Line "B".
- ⑫ To measure ground leakage current, press the I4 current probe trigger to open the jaw and then fully enclose the ground line "G".

5. Use the ▲ POWER ▼ key to select (P1, Q1, S1, PF1), (P2, Q2, S2, PF2) and (Pt, Qt, St, PFt).
6. To measure frequency, press the "Hz" key.  
To measure phase angle, press the "Θ" key.  
To measure ground leakage current, press the "I4" key.  
To measure power factor, press the "PF" key.
7. To measure energy, press the "ENERGY" key, the "Pt", "Qt", "St" and "PFt" or "ψt" annunciators and the energy integration start time will display. The energy integration value and the current time will be continually updated, press the "↵" key to pause the energy calculation; the HOLD annunciator will display. Press HOLD to exit the energy measurement mode.

### Three-Phase 3-Wire (3P3W) Power System Measurement

U1 must be connected to the voltage source during the measurement of U2, U3, I1, I2 and I3 since U1 is the main signal source of the entire meter measurement system.

A, B, C: Line, G: Ground;  Face the arrow toward the load

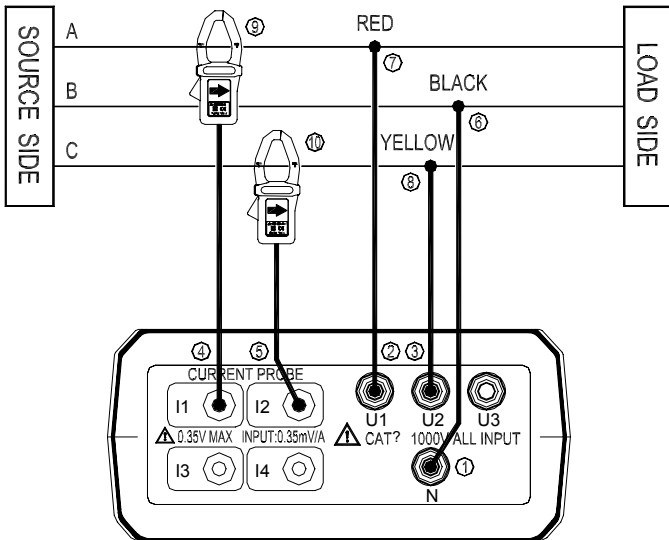

#### 3P3W Wiring Connection Diagram

1. Press the  key to turn the meter on.
2. Press the WIRING key to select 3P3W2M; the 3P3W2M annunciator will display.
3. Connect the voltage test leads and current probe to the meter.
  - ① Connect the black voltage test lead to the “N” terminal.
  - ② Connect the red voltage test lead to the “U1” terminal.
  - ③ Connect the yellow voltage test lead to the “U2” terminal.
  - ④ Connect the I1 current probe output plug to the “I1” jack.
  - ⑤ Connect the I2 current probe output plug to the “I2” jack.
4. Connect the voltage test leads and current probe to the electrical equipment to be tested.



**CAUTION:** Turn the meter off before connecting the voltage test leads and the current probe to the electrical equipment under test.

- ⑥ Connect the black voltage alligator clip to the line “B”.
- ⑦ Connect the red voltage alligator clip to the line “A”.
- ⑧ Connect the yellow voltage alligator clip to the line “C”.
- ⑨ Press the I1 current probe trigger to open the jaw, and then fully enclose Line “A”.
- ⑩ Press the I2 current probe trigger to open the jaw, and then fully enclose the Line “C”.

5. Use the ▲ POWER ▼ key to select (P1, Q1, S1, PF1), (P2, Q2, S2, PF2) & (Pt, Qt, St, PFt)
6. To measure frequency, press the "Hz" key.  
To measure phase angle, press the "Θ" key.  
To measure power factor, press the "PF" key.
7. To measure energy, press the "ENERGY" key, the "Pt", "Qt", "St" and "PF" or "ψt" annunciators and the energy integration start time will display. The energy integration value and the current time will continually update, press "↵" key to pause the energy calculation; the HOLD annunciator will display. Press HOLD to exit the energy measurement mode.

### Three-Phase 4-Wire (3P4W) Power System Measurement

U1 must be connected to the voltage source during the measurement of U2, U3, I1, I2 and I3 since U1 is the main signal source of the entire meter measuring system.

A, B, C: Line, N: Neutral, G: Ground;  Face the arrow toward the load.

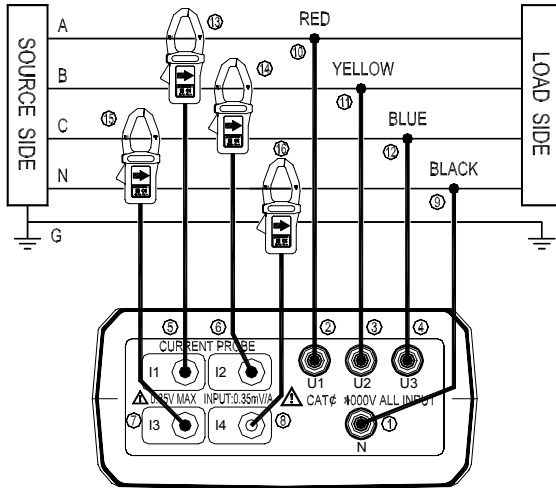

**3P4W Wiring Connection Diagram**

1. Press the  key to turn the meter on.
2. Press the WIRING key to select 3P4W; the 3P4W annunciator will display.
3. Connect the voltage test leads and the current probe to the meter.
  - ① Connect the black voltage test lead to the "N" terminal.
  - ② Connect the red voltage test lead to the "U1" terminal.
  - ③ Connect the yellow voltage test lead to the "U2" terminal.
  - ④ Connect the blue voltage test lead to the "U3" terminal.
  - ⑤ Connect the I1 current probe output plug to the "I1" jack.
  - ⑥ Connect the I2 current probe output plug to the "I2" jack.
  - ⑦ Connect the I3 current probe output plug to the "I3" jack.
  - ⑧ Connect the I4 current probe output plug to the "I4" jack.
4. Connect the voltage test leads and current probe to the electrical equipment to be tested.



**CAUTION:** Turn the meter off before connecting the voltage test leads and the current probe to the electrical equipment under test.

- ⑨ Connect the black voltage alligator clip to the neutral line "N".
- ⑩ Connect the red voltage alligator clip to line "A".
- ⑪ Connect the yellow voltage alligator clip to line "B".
- ⑫ Connect the blue voltage alligator clip to line "C".
- ⑬ Press the I1 current probe trigger to open the jaw and then fully enclose Line "A".
- ⑭ Press the I2 current probe trigger to open the jaw and then fully enclose Line "B".
- ⑮ Press the I3 current probe trigger to open the jaw and fully enclose Line "C".
- ⑯ Press the I4 current probe trigger to open the jaw and fully enclose neutral line "N".

5. Press the ▲POWER▼ key to select (P1, Q1, S1, PF1), (P2, Q2, S2, PF2), (P3, Q3, S3, PF3) or (Pt, Qt, St, PFt) groups.
6. To measure frequency, press the “Hz” key.  
To measure phase angle, press the “Θ” key.  
To measure neutral line current, press the “I4” key.  
To measure power factor, press the “PF” key.
7. To measure energy, press the “ENERGY” key, the “Pt”, “Qt”, “St” and “PF” or “ψt” annunciators and the energy integration start time will display. The energy integration value and the current time will continually display, press the “↵” key to pause the energy calculation; the **HOLD** annunciator will display. Press the HOLD key to exit the energy measurement mode.

#### I4 Current Measurement

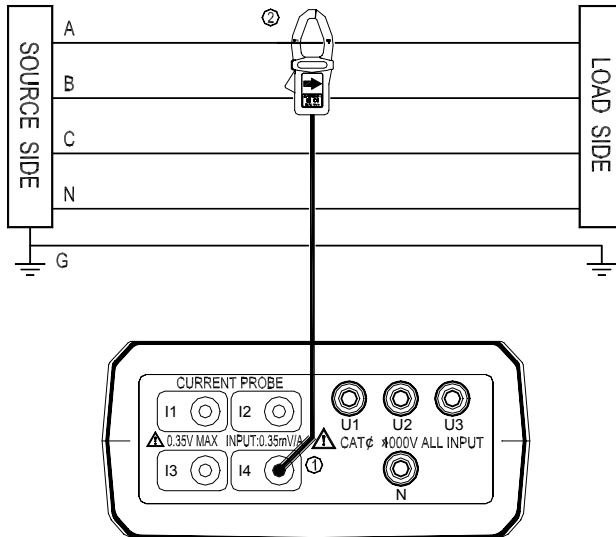



1. Press the **I** key to turn the meter on.
2. Press the “I4” key.
3. Connect the I4 current probe output plug to the “I4” jack.
4. Press the I4 current probe trigger to open the jaw and then fully enclose the desired measured wire.
5. Read the I4 value, if the measured current value is greater than 250A, the “OL” symbol will appear.



## Manual Datalogger Record and Recall Mode



### Clear memory data

1. Press the  key to turn the meter off.
2. Press and hold the MEMORY key and then press the  key again to turn the meter on; the “CLR” annunciator will display and all the manually logged data will be erased.

### Manually record data

1. Press the MEMORY key once to store one reading (1 set). The  annunciator will display momentarily along with the memory address.
2. Memory size for the manually recorded data is 99 sets max.

### Recall manually stored data

1. Press the READ key and the R annunciator will display.
2. Use the   keys to scroll through the stored data; the location (address) for each data will also display.
3. Press the “” key to exit the recall mode.









## Automatic Datalogging

### Clearing memory data

As a safeguard against accidentally deleted logged data the Power Analyzer memory can only be cleared through the software.

Please refer to the software operation section for instructions to clear the data.

### Setting the Calendar Clock and the Automatic Datalogging Sampling Interval

1. Press the TIME key and then quickly press the SET key. Seconds will start blinking.
2. Use the     keys to set the current YEAR-month, DAY-hour, minutes-seconds
3. Press the “” key to access the sampling interval mode; the “INTV” annunciator will display.
4. Use the   keys to select the sampling interval (5 seconds, 30 seconds, 1 minute or 2 minutes).
5. Press the  key to exit this mode.

### Automatic Datalogging Operation

1. Press the START key to begin automatic datalogging: DATA M $\times$  (block number) will display. The M annunciator will appear each time a reading is recorded.
2. Press the STOP key to pause logging; press START to resume.
3. Data can be recorded in up to 10 memory blocks; the current block number is displayed while logging (the maximum recording capacity is 20,000 readings).
4. When the maximum block or maximum reading limit is reached, the “FF” annunciator will be displayed and datalogging will stop.

### Downloading Data to a PC





Please refer to the software operation section for data download instructions..

## Phase Sequence Measurements

1. Press the  key to turn the meter on.
2. Use the WIRING key to select 3P4W.
3. Connect the voltage test leads to the meter.
  - Connect the red voltage test lead to the “U1” terminal.
  - Connect the yellow voltage test lead to the “U2” terminal.
  - Connect the blue voltage test lead to the “U3” terminal.
4. Connect the voltage test leads to the electrical equipment to be tested.



CAUTION: Turn the meter off before connecting the voltage test leads and the current probe to the electrical equipment under test.



- Connect the red voltage alligator clip to power line “A” phase.
  - Connect the yellow voltage alligator clip to power line “B” phase.
  - Connect the blue voltage alligator clip to power line “C” phase.
5. U1, U2 and U3 measured voltages must be greater than 30V.
    - Press and hold the “” key.
    - If the phase sequence is clockwise, the “” annunciator is displayed.
    - If the phase sequence is counter-clockwise, the “” annunciator is displayed.
    - Release the “” key to exit this measurement mode.

## Voltage/Current Waveform and Harmonic Analyzer

Please refer to the software operation section for waveform and harmonic measurement details.

## Disabling the Auto Power-Off Feature

The meter automatically enters the sleep mode after approx. 30 minutes to conserve battery power.

1. To disable this feature:
  - Press the  key to turn the meter off.
  - Press and hold the HOLD key and then press the  key to turn the meter on. The auto power off symbol “” will switch off indicating Auto Power off is disabled.
2. The Auto power off mode is enabled each time the meter is turned on. It is automatically disabled in the following modes:
  - ENERGY mode
  - Automatic datalogging
  - When Meter is connected to PC

## *RS-232 PC Interface*

---

Connect the Optical Interface connector to the 382090 Power Analyzer (middle pin is keyed for correct orientation). Connect the 9-pin female connector to the 9-pin serial PC port (COM1 or COM2).

### **PC Requirements**

- 486-33 IBM compatible PC or better
- One CD-ROM drive
- Available serial port.
- Windows 95, 98, 2000, NT, ME, XP Operating System

### **Installing the Windows Application Program**

1. Place the supplied software CD in the PC CD-ROM drive
2. Wait for "Autorun" to start and follow the on-screen instructions
3. If "Autorun" does not start, click on "Start" then "Run". Type the drive letter of the CD-ROM and :\\B\\Disk1\\Setup.exe and click OK (To install the LabVIEW version, type the drive letter and :\\LV\\installer\\Setup.exe and click OK).
4. Change the path if necessary or choose install the program to its default location.
5. Launch the program by double clicking the program file in the location where it was saved during installation.
6. Remember not to run the supplied software until the meter is properly connected to the PC as described earlier.

## *Software Operation*

---

Instructions on using the software are included on the CD-ROM.  
Open the file called [382090 Software Manual.pdf](#) to access the manual.

# Specifications

---

## Environmental Conditions

- Installation categories III
- Pollution degree
- Altitude up to 2000 meters
- Indoor use only
- Relative humidity 80% max.
- Operational ambient temperature 32 to 122°F (0 to 50°C)

## General Specifications

Maximum voltage between voltage input terminals and earth ground: 1000 Vrms

Maximum rated working voltage for current input: 0.35Vrms

Maximum current for current probe: 1000A rms

Display: Ten (10) 4-digit LCD displays (maximum reading 9999)

Battery life: approx. 50 hours

Auto power off: After approx. 30 minutes

Low battery indication:  is displayed when battery voltage falls low

Backlight display time: Automatically turns off approx. 30 seconds

Sampling rate: Approx. 1 display update every 2 seconds (digital display)

Waveform and harmonic analyzer: 54 samples per period

Current probe jaw opening diameter: Cables  $\varnothing$ 40mm

Operating temperature and humidity: 32 to 122°F (0 to 50°C); R.H. <80% non-condensing

Temperature coefficient:  $0.1 \times$  (specified accuracy) / <64 or >82°F (<18 or >28°C)

Storage temperature and humidity: 14 to 140°F (-10 to 60°C); R.H. < 70% non-condensing

Dimensions (meter): 9.2(L) x 4.6(W) x 2.1(H)"; [235(L) x 117(W) x 54(H)mm]

Dimensions (Current probes): 7.6(L) x 3.5(W) x 1.6(H)"; [193(L) x 88(W) x 40(H)mm]

Weight: Meter: approx. 25.8 oz (730g); Current probe: approx. 11.6oz (333g)

**Safety** For indoor use and in accordance with the requirements for double insulation to IEC1010-1 (1995): EN61010-1 (1995) Overvoltage Category III 1000V, Pollution Degree 2.

## Electrical Specifications

Accuracy:  $\pm$  (% of reading + number of digits) at 64 to 82°F (18 to 28°C) with relative humidity to 80%

### AC Voltage True rms measurements (V)

| Range  | Resolution | Accuracy                             | Input impedance | Overload protection | Nominal frequency              |
|--------|------------|--------------------------------------|-----------------|---------------------|--------------------------------|
| 999.9V | 0.1V       | $\pm (0.5\%rdg + 10d)$<br>( $>80V$ ) | 2M $\Omega$     | 1000Vrms            | 50Hz (382091)<br>60Hz (382090) |

- Display: RMS voltage value for each channel

### AC Current True rms Measurement (A) Autoranging

| Ranges                     | Resolution | Accuracy (including current probe) | Current probe output | Overload protection | Nominal frequency              |
|----------------------------|------------|------------------------------------|----------------------|---------------------|--------------------------------|
| 250.0A<br>500.0A<br>999.9A | 0.1A       | $\pm(2\%rdg + 20d)$                | 0.35mV/A             | 1000Arms            | 50Hz (382091)<br>60Hz (382090) |

- Display: RMS current value for each channel

### Active Power measurement P (KW)

| Range   | Resolution | Accuracy (PF=1)        | Power factor influence (PF=0.5) |
|---------|------------|------------------------|---------------------------------|
| 999.9KW | 0.1KW      | $\pm (1.5\%rdg + 20d)$ | $\pm (1\%rdg + 10d)$            |

- Display: Active power of each channel and the sum of multiple channels
- Polarity display: For influx (consumption) no symbol; For outflow (regenerative) " - " sign

### Apparent Power measurement S (KVA)

| Range    | Resolution | Accuracy (PF=1)        | Power factor influence (PF=0.5) |
|----------|------------|------------------------|---------------------------------|
| 999.9KVA | 0.1KVA     | $\pm (1.5\%rdg + 20d)$ | $\pm (1\%rdg + 10d)$            |

- Measurement method: Calculated from RMS voltage U and RMS current I.
- Displays: Apparent power of each channel and the sum of multiple channels.
- Polarity display: Positive assumed

### Reactive Power measurement Q (KVAR)

| Range     | Resolution | Accuracy (PF=1)        | Power factor influence (PF=0.5) |
|-----------|------------|------------------------|---------------------------------|
| 999.9KVAR | 0.1KVAR    | $\pm (1.5\%rdg + 20d)$ | $\pm (1\%rdg + 10d)$            |

- Measurement method: Calculated from apparent power S and active power P.
- Displays: Reactive power of each channel and the sum of multiple channels.
- Polarity display: For phase lag (LAG) current is behind voltage: No symbol. For LEAD phase (LEAD: current ahead of voltage): "-" sign

**Power Factor measurement (COS $\psi$ )**

| Range       | Resolution | Accuracy             |
|-------------|------------|----------------------|
| -1 ~ 0 ~ +1 | 0.001      | $\pm (3\%rdg + 30d)$ |

- Measurement method: Calculated from apparent power S and active power P.
- Displays: Power factor of each channel and the sum of multiple channels.
- Polarity display: For phase lag (LAG) current is behind voltage: No symbol; for phase lead (LEAD) current is ahead of voltage: "-" sign

**Phase angle measurement ( $\psi$ )**

| Range                        | Resolution  | Accuracy  |
|------------------------------|-------------|---|
| $\pm 11^\circ$ to $90^\circ$ | $0.1^\circ$ | >50A: $\pm 3^\circ + 30d$ digits,<br>25 to 50A: $\pm 4^\circ + 40d$ igits<br>(<25A unspecified) |



- Measurement method: Calculated from power factor COS $\psi$
- Display item: Phase angle of each channel and the sum of multiple channels.
- Polarity display: For phase lag (LAG: current is behind voltage): No symbol. For phase lead (LEAD: current is ahead of voltage): "-".

**Frequency measurement (Hz)**

| Range | Resolution | Accuracy             | Measurement source |
|-------|------------|----------------------|--------------------|
| 60HZ  | 0.01Hz     | $\pm(0.5\%rdg + 1d)$ | Voltage U1 > 80V   |

- Measurable input range : > 30V

**Three Phase Sequence Detection**

| Input voltage range | Normal phase indication   | Reverse phase indication  | Meas. source  |
|---------------------|---|---|---------------|
| 3P > 30V            | <b>123</b><br> | <b>123</b><br> | U1, U2 and U3 |

**Active Power Energy measurement (KWh)**

| Range    | Resolution | Active power accuracy  | Timer interval | Timer Accuracy                                  |
|----------|------------|------------------------|----------------|---|
| 3.999KWh | 0.001KWh   | $\pm (1.5\%rdg + 20d)$ | 1 sec          | $\pm 50ppm$ at $77^\circ F$<br>( $25^\circ C$ ) |
| 39.99KWh | 0.01KWh    |                        |                |   |
| 399.9KWh | 0.1KWh     |                        |                |   |
| 3.999MWh | 0.001MWh   |                        |                |   |
| 39.99MWh | 0.01MWh    |                        |                |   |
| 119.3MWh | 0.1MWh     |                        |                |   |

- Measurement display: Displays total active power consumption

**Apparent Power Energy measurement (KVAh)**

| Range     | Resolution | Apparent power accuracy | Timer interval | Timer Accuracy                                  |
|-----------|------------|-------------------------|----------------|---|
| 3.999KVAh | 0.001KVAh  | $\pm (1.5\%rdg + 20d)$  | 1 sec          | $\pm 50ppm$ at $77^\circ F$<br>( $25^\circ C$ ) |
| 39.99KVAh | 0.01KVAh   |                         |                |   |
| 399.9KVAh | 0.1KVAh    |                         |                |   |
| 3.999MVAh | 0.001MVAh  |                         |                |   |
| 39.99MVAh | 0.01MVAh   |                         |                |   |
| 119.3MVAh | 0.1MVAh    |                         |                |   |

- Measurement display: Displays total apparent power energy (sum of absolute values).

**Reactive Power Energy measurement (Kvarh)**

| Range      | Resolution | Reactive power accuracy | Timer interval | Timer Accuracy        |
|------------|------------|-------------------------|----------------|-----------------------|
| 3.999Kvarh | 0.001Kvarh | ±(1.5%rdg + 20d)        | 1 sec          | ±50ppm at 77°F (25°C) |
| 39.99Kvarh | 0.01Kvarh  |                         |                |                       |
| 399.9Kvarh | 0.1Kvarh   |                         |                |                       |
| 3.999Mvarh | 0.001Mvarh |                         |                |                       |
| 39.99Mvarh | 0.01Mvarh  |                         |                |                       |
| 119.3Mvarh | 0.1Mvarh   |                         |                |                       |

- Measurement display: Displays total reactive power consumption

**Harmonic measurement (for use with PC on-line analyzer only)**

| Order  | Accuracy | Harmonic Source                     | No. of samples per period |
|--------|----------|-------------------------------------|---------------------------|
| 1 ~ 27 | ±3%THD   | U1, U2, U3 > 100V; I1, I2, I3 > 50A | 54                        |

## Maintenance

---

### Cleaning

Periodically wipe the case with a dry cloth. Do not use abrasives or solvents.

### Battery Replacement



**WARNING:** To avoid electrical shock, remove the test leads and current probe before replacing the batteries.

1. The LCD will display **BT** (low battery) when the battery power falls below proper operating levels.
2. Disconnect all test leads and current probes and press the **I** key to turn the meter off.
3. The battery cover is secured at the bottom of the meter case by two screws. Remove these screws to access the battery compartment.
4. Replace the batteries observing polarity and reassemble the meter.

## Calibration and Repair Services

---

**Extech offers repair and calibration services** for the products we sell. Extech also provides NIST certification for most products. Call the Customer Service Department for information on calibration services available for this product. Extech recommends that annual calibrations be performed to verify meter performance and accuracy.



### **Support Hotline (781) 890-7440**

Tech support: Ext. 200; Email: [support@extech.com](mailto:support@extech.com)  
Repair>Returns: Ext. 210; Email: [repair@extech.com](mailto:repair@extech.com)  
Website: [www.extech.com](http://www.extech.com)

**Copyright © 2004 Extech Instruments Corporation**

All rights reserved including the right of reproduction in whole or in part in any form.